

# twilight

INSTRUMENTOS DE MEDICIÓN INDUSTRIAL

## Kit de Adherencia PT-AR

[www.twilight.mx](http://www.twilight.mx)

 / [twightsadecv](https://www.facebook.com/twightsadecv)

 / [twightsadecv](https://twitter.com/twightsadecv)

 / [twightsadecv](https://www.youtube.com/twightsadecv)

---

# Cross-Cut Tape Test

## Instructions



### **Precision Gage & Tool Co.**

375 Gargrave Road  
Dayton, Ohio 45449

Phone: (937) 866-9666 • Fax: (937) 866-9661  
www.pgtgage.com • email: info@pgtgage.com

## Materials

The Cross-Cut Kit by Precision Gage & Tool Company provides almost everything you need to perform Adhesion and Flexibility Tests to meet the standards of ASTM Test method D-3359. In the kit, you'll find a blade, a blade holder/handle, a hex wrench for changing blades, an extra clamp screw, a small flaking and cleaning brush, a lighted magnifier, and a roll of test tape. You'll also need a rubber eraser on the end of a pencil.

## Test Specimens

In the field, you'll test the actual coated structure or article you want to evaluate. In the lab, you may apply the materials you're testing to panels of the appropriate composition and surface conditions. Either way, the testing surface must be flat. You can check flatness with a straight edge such as a steel rule.

## Procedure

1. Make sure your specimen is at room temperature (or other mutually agreed upon temperature) and placed on a firm base.
2. Select an area free of blemishes and minor surface imperfections. Under the illumination of the magnifier, use the cross-cut tool to make parallel cuts as follows:
3. For dry film coatings of thickness of 2.0 mils (50  $\mu\text{m}$ ) or less, use a fine blade (1.0 mm spacing). For coatings having a dry film thickness between 2.0 mils (50  $\mu\text{m}$ )

and 5 mils (125  $\mu\text{m}$ ), choose a medium (1.5 mm spacing) or coarse (2.0 mm spacing) blade.

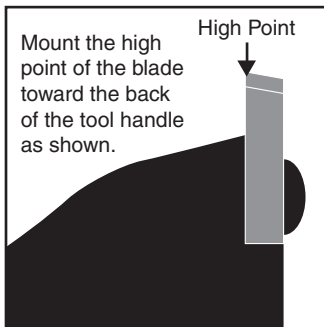

4. Make the first cut about 3/4 in. (20 mm) long. Cut through the film to the substrate in one steady motion, using just enough pressure to reach the substrate.
5. After making the cut, gently remove any detached flakes or ribbons from the film with your kit's brush.
6. Next, make a second cut at 90° to and centered on the original cuts to create a grid pattern in the film.
7. Brush the area again and inspect the cuts to make sure you've reached the substrate. If not, make another grid in a different location.
8. Remove two complete laps of your kit's test tape and discard. Remove an additional length at a steady rate (don't jerk it) and cut a piece about 3 in. (75 mm) long.

9. Place the center of the tape over the grid and smooth it into place. To make good contact with the film, rub the tape firmly with a pencil eraser. The color under the tape helps you determine when you've made good contact.
  10. Wait about 90 seconds, then remove the tape. Seize the free end and quickly (without jerking) pull it back upon itself as close as possible to a 180° angle.
  11. Using the kit's illuminated magnifier, inspect the grid area for coating removal. Rate the coating's adhesion according to the Classification scale below; **see back for illustrated Classification of Results table.**
- 5B** The edges of the cuts are completely smooth; none of the coating on the grid squares is detached.
- 4B** Small flakes have detached at intersections, affecting no more than approximately 5% of the area.
- 3B** Small flakes have detached along edges and at intersections of cuts. Approximately 5 to 15% of the grid is affected.
- 2B** The coating has flaked along the edges and on parts of the squares. Approximately 15 to 35% of the grid is affected.
- 1B** The coating has flaked in long strips along the cut edges, and whole squares have detached. Approximately 35 to 65% of the grid is affected.
- 0B** Flaking is worse than Grade 1B.

## Report

Report the number of tests, their mean and range, and where the failure occurred—i.e., between the first coat and substrate, between the first and second coat, etc. Note the substrate used, the type of coating and the method of cure.

If the adhesion strength of the tape has been determined in accordance with Test Methods D 1000<sup>1</sup> or D 3330<sup>2</sup>, report the results with the adhesion ratings. Otherwise, report the specific tape used.

## Precision and Bias

Use the following criteria to judge the acceptability of your results.

*Repeatability*— If adhesion is uniform over the surface being tested, results obtained for two measurements by the same operator should not differ by more than one rating category.

*Reproducibility*— Test results obtained by different operators (each the mean of two measurements) should not differ by more than two rating categories.

Bias cannot be established for these test methods.

<sup>1</sup> D 1000 Test Methods for Pressure-Sensitive Adhesive-Coated Tapes Used for Electrical and Electronic Applications; *Annual Book of ASTM Standards, Vol. 10.01.*

<sup>2</sup> D 3330 Test Method for Peel Adhesion of Pressure-Sensitive Tape for 180° Angle; *Annual Book of ASTM Standards, Vol. 15.09.*

## Classification of Results

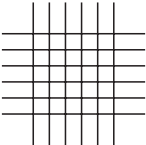
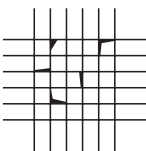
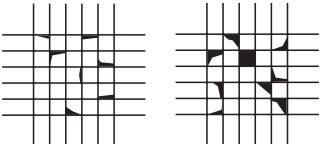
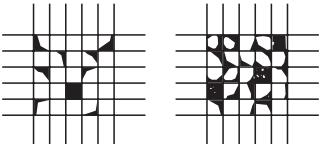
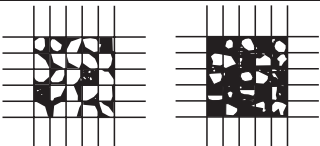
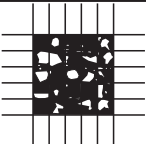
Classification for percentage of area removed	Surface of crosscut area (six each horizontal and vertical parallel cuts) where flaking has occurred: adhesion range by percent.*
<b>5B</b> – 0% None	
<b>4B</b> – Less than 5%	
<b>3B</b> – 5% to 15%	
<b>2B</b> – 15% to 35%	
<b>1B</b> – 35% to 65%	
<b>0B</b> – Greater than 65%	

\*For illustration purposes only.

## **Tape used in the ASTM D3359 Measuring Adhesion by Tape Test – November, 2010**

Permacel 99 tape, used prior to May, 2010 in the Precision Gage & Tool Cross Cut Tape Test Kit to perform the ASTM D3359 Measuring Adhesion by Tape Test, has been discontinued by its manufacturer. In place of Permacel 99 tape, Precision Gage & Tool will continue to serve it's customers by offering 51596 tape manufactured by Interpolymer Group. Experience in the field indicates that 51596 tape has similar properties to the tapes previously recommended for the ASTM D3359 test; however, customers are advised that the ASTM has not completed laboratory testing of tapes to replace Permacell 99 tape. Users should report in their documentation any differences in the results using 51596 tape compared to past results. We would appreciate any user feedback on experiences with 51596 tape.



### **Precision Gage & Tool Co.**

375 Gargrave Road  
Dayton, Ohio 45449

Phone: (937) 866-9666 • Fax: (937) 866-9661  
www.pgtgage.com • email: info@pgtgage.com

# twilight

INSTRUMENTOS DE MEDICIÓN INDUSTRIAL



LLÁMANOS

+52(81) 8115-1400 / +52 (81) 8173-4300

LADA Sin Costo:  
01 800 087 43 75

E-mail:  
[ventas@twilight.mx](mailto:ventas@twilight.mx)

[www.twilight.mx](http://www.twilight.mx)