

— WARNING —

1. Test samples can break or shatter, wear eye and body protection to avoid injury.
2. Do not exceed 275 lbf capacity. Be sure to set the upper and lower travel limits to avoid overload.
3. To reset from an overload lockup see page 7.

2 YEAR WARRANTY (restrictions apply)

Imada, Inc. warrants its products to the original purchaser to be free from defects in workmanship and material under normal use and proper maintenance for two years (one year for adapters, attachments, and cables) from original purchase. This warranty only covers defective material and labor and does not cover calibration, batteries, freight, fees and expenses and shall not be effective if the product has been subject to overload, shock load, misuse, negligence, accident or repairs attempted by others than Imada, Inc.

During the warranty period, we will, at our option, either repair or replace defective products. Please call our customer service department for a return authorization number and return the defective product to us with freight prepaid.

The foregoing warranty constitutes the SOLE AND EXCLUSIVE WARRANTY, and we hereby disclaim all other warranties, express, statutory or implied, applicable to the products and/or software, including but not limited to all implied warranties of merchantability, fitness, non-infringement, results, accuracy, security and freedom from computer virus. In no event shall Imada, Inc. and/or its affiliated companies be liable for any incidental, consequential or punitive damages in connection with the use of its products and/or software.



Imada, Inc.®

3100 Dundee Rd., Suite 707, Northbrook, IL 60062 USA

Telephone: (847) 562-0834 Fax: (847) 562-0839

www.imada.com E-mail: imada@imada.com

ISO 9001 & ISO/IEC 17025 Accredited

10/12

Specifications subject to change without notice.

HORIZONTAL MOTORIZED TEST STAND

Model MH-275

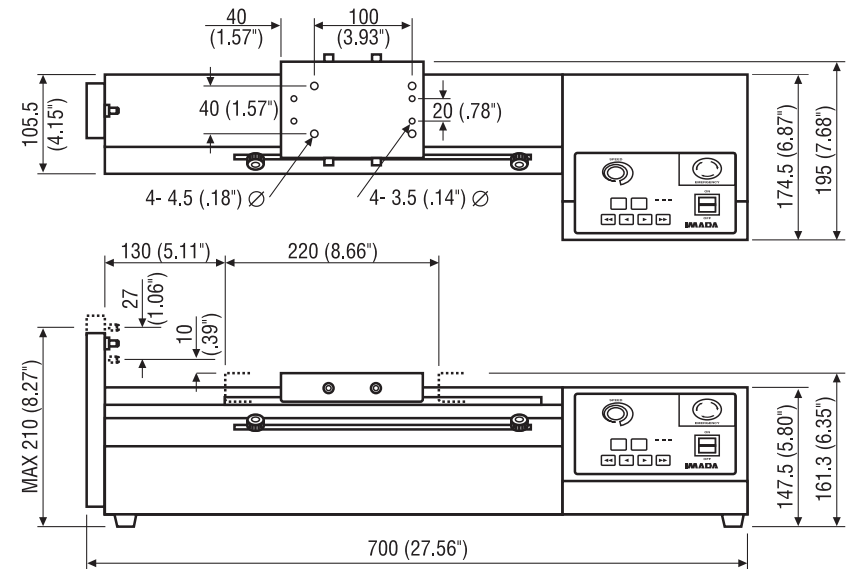

FORCE GAUGE AND DIGITAL DISTANCE METER SOLD SEPARATELY

INSTRUCTION MANUAL

INTRODUCTION

The Model MH-275 Horizontal Motorized Test Stand assures consistent, identical measuring conditions by eliminating possible human error.

SPECIFICATIONS

Motorized Horizontal Test Stand

Model No: MH-275
 Max Load: 275 lbf
 Speed: 0.3"~ 7"/minute
 Stroke: 9.5" (241.3 mm)
 Power: 115/230 VAC

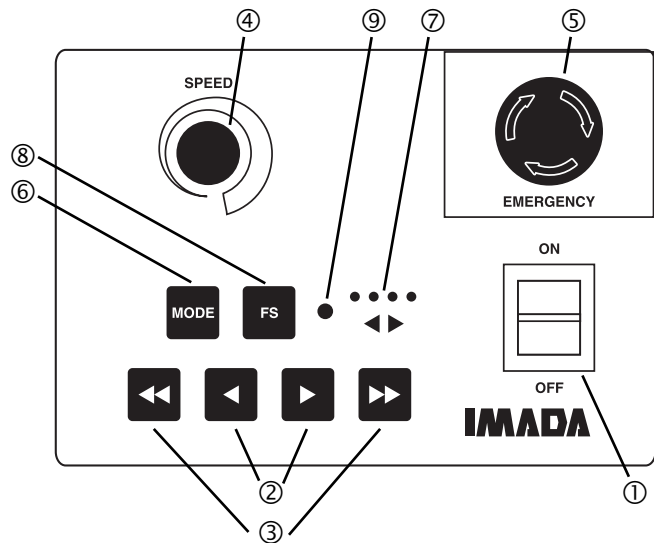

CONTROL PANEL

- ① Power Switch
- ② Adjustable Speed Direction Switch
- ③ Maximum Speed Direction Switch
- ④ Speed Adjust Knob
- ⑤ Emergency Stop Switch
- ⑥ Mode Switch
- ⑦ Mode Indicators
- ⑧ Fixed Speed Switch
- ⑨ Fixed Speed Adjustment

RESET FROM OVERLOAD LOCKUP

If the test stand overloads or locks up during testing, disconnect the cable connecting the test stand to the force gauge, switch to Manual Operation and using a direction switch, back off the crosshead (in the opposite direction from the overload) to release the load.

CONDITIONAL OVERLOAD PREVENTION

When a Z series force gauge is mounted and connected to an MX stand with a CB-501/504 cable, Conditional Overload Prevention will engage at 110% of gauge capacity and stop test stand movement. Depending upon test speed and other variables, movement may be stopped quickly enough to prevent damage to the gauge.

TRAVEL LIMITS

LEFT TRAVEL LIMIT

Head stops going left when it reaches this position. To adjust the stroke, loosen screw and move the limit to desired position. Re-tighten screw securely.

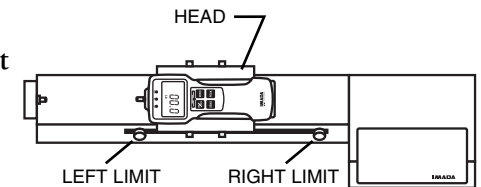

RIGHT TRAVEL LIMIT

Head stops going right when it reaches this position. To adjust the stroke, loosen screw and move the limit to desired position. Re-tighten screw securely.

CAUTION

Make sure the left limit is set to allow adequate clearance for the force gauge and attachments, so it doesn't crash into the test fixture and overload the gauge.

5. Press ZERO switch on Z2 gauge and start testing.

High/Low Setpoints Force Control

Momentarily press the Direction Switch  (left or right). The Cross Head moves (left or right) at the speed set by Speed Adjust Knob ④ or the speed set by the Fixed Speed Switch ⑧. When the force value reaches the Low setpoint, force control is activated to maintain the force between the High and Low setpoints programmed on the Z2 gauge. To end force control, press the Emergency Switch ⑤.

Single Preset One Way Force Control

Momentarily press the Max. Speed Direction Switch  (left or right). The Cross Head moves (left or right) at maximum speed until the force value reaches the Low setpoint. Then the speed changes to the one set by Speed Adjust Knob ④ or the speed set by Fixed Speed Switch ⑧. When the force value reaches the High setpoint programmed on the Z2 gauge, the test stops.

RESET FROM OVERLOAD

If the test stand overloads or locks up during testing, disconnect the cable from test stand to force gauge, switch to Manual Operation and using the direction switch, back off the crosshead (in the opposite direction from the overload) to release the load.

EMERGENCY BRAKE STOP SWITCH

Push the **Emergency Stop Switch** ⑤ whenever you are in an emergency situation. To re-engage the **Emergency Stop Switch**, simply turn the switch clockwise.

CONDITIONAL OVERLOAD PREVENTION

When a Z series force gauge is mounted and connected to an MX stand with a CB-501/504 cable, Conditional Overload Prevention will engage at 110% of gauge capacity and stop test stand movement. Depending upon test speed and other variables, movement may be stopped quickly enough to prevent damage to the gauge.



GENERAL OPERATION

Make sure of the following before plugging the power cord into the 115/230 VAC output.

1. Turn **Speed Adjustment Knob** ④ to a middle position.
2. Turn the **Emergency Switch** ⑤ clockwise to make sure the Emergency Brake is released.
3. Move the left or right travel limits so that there is separation between them (see Page 7 of this manual).
4. Connect power cord to stand and plug into 115/230 VAC outlet.
5. Turn on Power Switch ①. The Orange power lamp will light.

MANUAL OPERATION

When the Power is turned on, startup mode is Manual Operation. Press the **Mode Switch** ⑥ to select other modes Single Cycle, Continuous Cycle, the appropriate Mode Indicator will light ⑦.

1. Press Mode Switch ⑥ and select Manual Operation, the Mode Indicator lights ⑦.
2. When the  **Direction Switch** is pressed, the Cross Head moves left, stopping when it reaches the left travel limit. When the  **Direction Switch** is pressed the Cross Head moves right, stopping when it reaches the right travel limit.
3. Select test speed
 - A. Turn the Speed Adjust Knob ④
 - B. Press Fixed Speed Switch ⑧, the Mode Indicator lights ⑦. (overrides Speed Adjust Knob). Fixed Speed can be adjusted by using a small screwdriver to adjust the Fixed Speed Adjustment potentiometer ⑨.
4. Regardless of the preset speed, when the **Quick Switch**  is pressed, either left or right, the Cross Head moves at maximum speed.

SINGLE CYCLE OPERATION

1. Press the Mode switch ⑥ and select Single Cycle Mode.
2. Press Peak switch on Z2/ZP gauge and select real time mode.
3. Select test speed
 - A. Turn the Speed Adjust Knob ④ or;
 - B. Press Fixed Speed Switch ⑧. Fixed Speed Indicator lights and overrides Speed Adjust Knob. Fixed speed can be changed using a small screwdriver to adjust the FS potentiometer.
4. Press Zero switch on the Z2/ZP gauge.
5. Press the maximum speed ◀ or slow speed ▶ direction switch to start testing. The double arrow switch moves the cross head left or right at maximum speed and the single arrow at the speed selected in step three.
6. If the double arrow switch is pressed, the cross head moves left or right at maximum speed until the Low setpoint force value programmed on the Z2/ZP force gauge is reached, then it slows to the speed selected in step three.
7. When the force value reaches the High setpoint or the cross head reaches the travel limit, the cross head stops.
8. After pausing 0.5 seconds the cross head moves in the opposite direction at maximum speed.
9. Upon reaching the opposite travel limit, the test is complete.
10. To stop a test anytime, press one of the direction switches.

CONTINUOUS CYCLE OPERATION

1. Press the Mode switch ⑥ and select Continuous Cycle Mode.
2. Press Peak switch on Z2/ZP gauge and select real time mode.
3. Select test speed
 - A. Turn the Speed Adjust Knob ④ or;
 - B. Press Fixed Speed Switch ⑧. Fixed Speed Indicator lights and overrides Speed Adjust Knob. Fixed speed can be changed using a small screwdriver to adjust the FS potentiometer.
4. Press Zero switch on the Z2/ZP gauge.
5. Press the maximum speed ◀ or slow speed ▶ direction switch to start testing. The double arrow switch moves the

- cross head left or right at maximum speed and the single arrow at the speed selected in step three.
6. If the double arrow switch is pressed, the cross head moves left or right at maximum speed until the Low setpoint force value programmed on the Z2/ZP force gauge is reached, then it slows to the speed selected in step three.
7. When the force value reaches the High setpoint or the cross head reaches the travel limit, the cross head stops.
8. After pausing 0.5 seconds the cross head moves in the opposite direction at maximum speed.
9. When the cross head reaches the opposite travel limit, it stops and then cycles from step 5 to step 9 continuously.
10. To stop a test anytime, press one of the direction switches.

FORCE CONTROL OPERATION

MH-275 test stand can be used as a force controller when it is used together with an IMADA Z2 digital force gauge and CB-501 interface cable. This feature may be used as overload protection and can help prevent overload damage in most cases, but due to the wide variety of testing conditions a guarantee is not possible.

1. Connect MH-275 test stand and IMADA Z2 force gauge with a CB-501 interface cable.
2. Program High and Low setpoints on IMADA Z2 force gauge. (Refer to Z2 Manual Programming Setpoints section)
3. Press **Mode Switch** ⑥ and select Continuous Cycle. **Press Mode switch again and the Continuous Cycle light begins blinking** ⑦.
4. Select test speed:
 - A. Turn the Speed Adjust Knob ④
 - B. Press Fixed Speed Switch ⑧, the Mode Indicator lights ⑦. (overrides Speed Adjust Knob). Fixed Speed can be adjusted by using a small screwdriver to adjust the Fixed Speed Adjustment potentiometer ⑨.