

# twilight

INSTRUMENTOS DE MEDICIÓN INDUSTRIAL

## Refractometro y Acidez para Cereza de Café

AT-PALBX\_ACID40KIT

[www.twilight.mx](http://www.twilight.mx)

 / [twightsadecv](https://www.facebook.com/twightsadecv)

 / [twightsadecv](https://twitter.com/twightsadecv)

 / [twightsadecv](https://www.youtube.com/twightsadecv)

# Pocket Brix-Acidity Meter (Coffee cherry) Master Kit

7140-E03

**ATAGO**  
Instruction Manual

## PAL-BX|ACID40

Cat. No. 7140

### Parts



**LCD**  
Displays the measured values, sensor temperature, and battery indicator. The instrument will turn itself off after 2 minutes of inactivity. To manually turn it off, hold down the START button for more than 2 seconds.

**START Button**  
Press to take measurement. To turn off the display, press and hold for more than 2 seconds.

**R Button**  
Press the button to show the sugar and acidity ratio.

**Battery Compartment**  
Place and remove batteries from here.



**Sample Stage**  
Place sample on the sensor located at the center of the sample stage.

**ZERO Button**  
Press to perform zero-setting.

**Lanyard Hole**

### Contents

Main unit...1 Instruction Manual (this book)...1 AAA batteries...2 Measuring Spoon 1mL...1 Beaker 100mL...1 Digital scale...1 (About the Digital Scale)

**Note**Please remove the tape in the battery compartment before first use.

**Memo**The measuring spoon is available from ATAGO. Part No. RE-39005 Measuring Spoon 1mL

ATAGO instruments are rigorously inspected to ensure each unit meets the highest standards of quality assurance.

### Quick Tips

The instrument measures the Brix in the sample solution, and the acidity in the 1: 50 dilution of the sample that is diluted with purified water.

Press the START button once to measure the Brix. The Brix and the acidity of the sample (stock-solution) will be displayed at the end of the measurement.



Press the ZERO button to perform zero-setting for either Brix or Acidity. Zero-setting can be performed with water (for Brix) or air (for acidity)

**LCD Auto Shut-off**  
The instrument will turn itself off after 2 minutes of inactivity. To manually turn it off, hold down the START button for more than 2 seconds.

### Zero-setting and Measurement

#### Preparation

**Note**Recommended on a daily basis.

#### Acid: Zero-setting

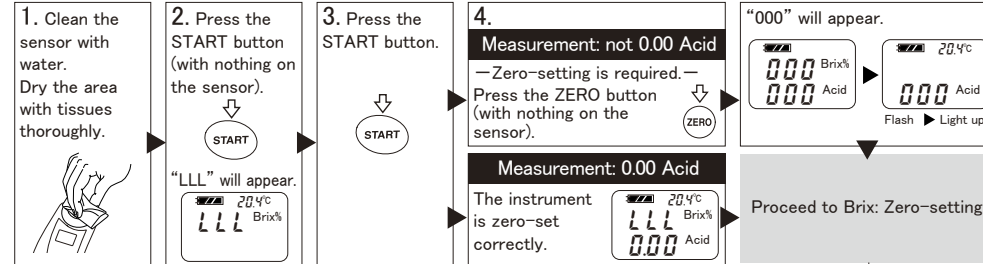

#### Brix: Zero-setting

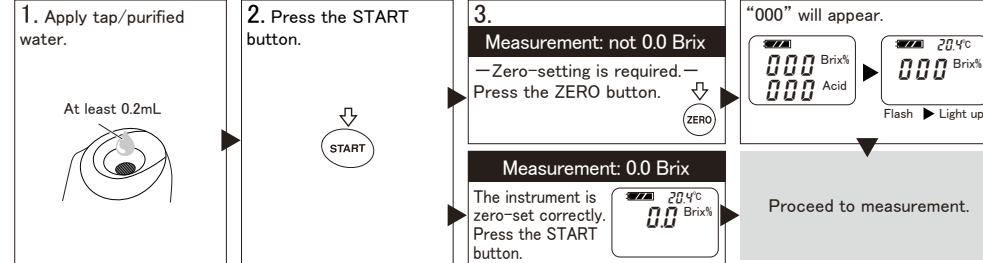

#### Measurement

[1]Acid: Dilution (About the Digital Scale)

**Memo**Necessary Materials  
Digital scale, Beaker 100mL

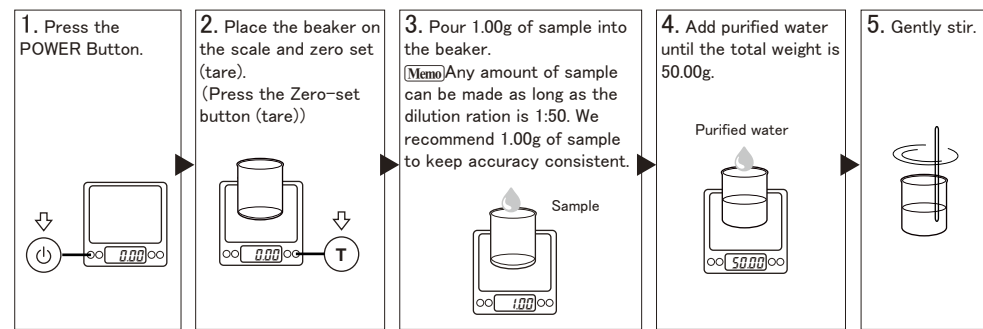

#### [2]Measuring the Brix

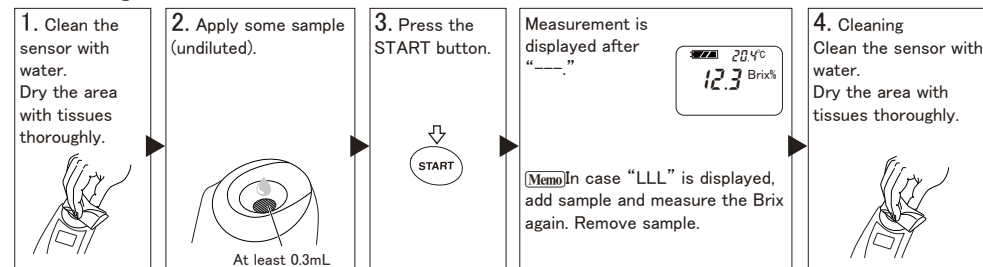

#### [3]Measuring the Acidity

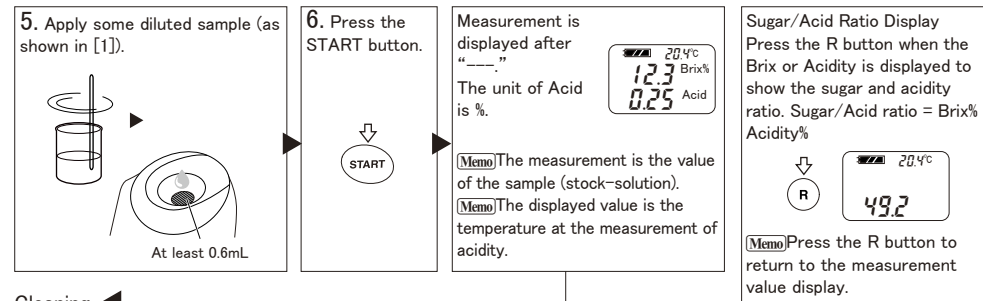

#### Cleaning

Wipe off the sample. Clean the sensor with water. Dry the area with tissues thoroughly. Clean oily residues with mild soap, and then, rinse with water. **Note**Handle the sensor with care so as not to scratch it.

### Addendum

Acid: Measuring Without using a Scale

For approximate measurement only

[1]Acid: Dilution

**Memo**Necessary Materials

Measuring spoon 1mL, Beaker 100mL

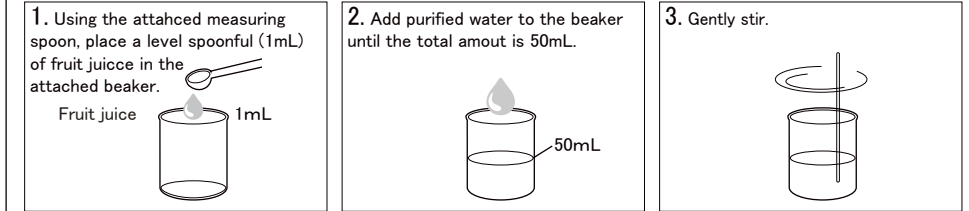

#### [2]Measuring the Brix

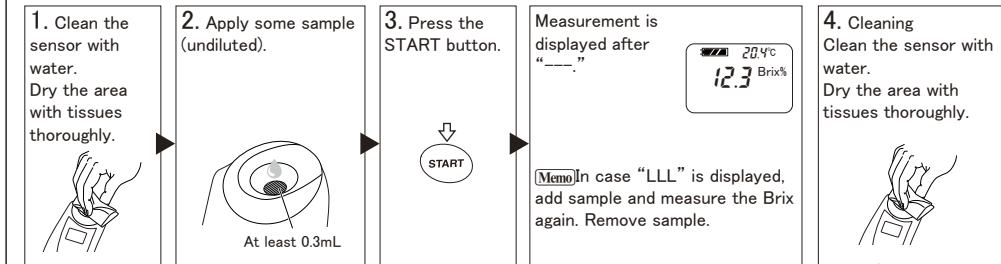

#### [3]Measuring the Acidity

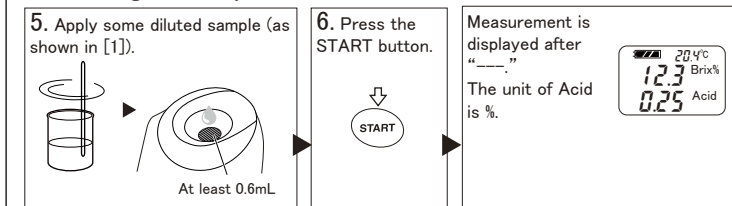

### Acid: Checking with Reference Solution

When there is any doubt regarding accuracy of measurement results, adjust the reference value according to the following procedure.

**Memo**The reference solution is available from ATAGO. Part No. RE-130004 Reference solution (0.04% Citric acid solution)

#### Acid: Checking with Reference Solution

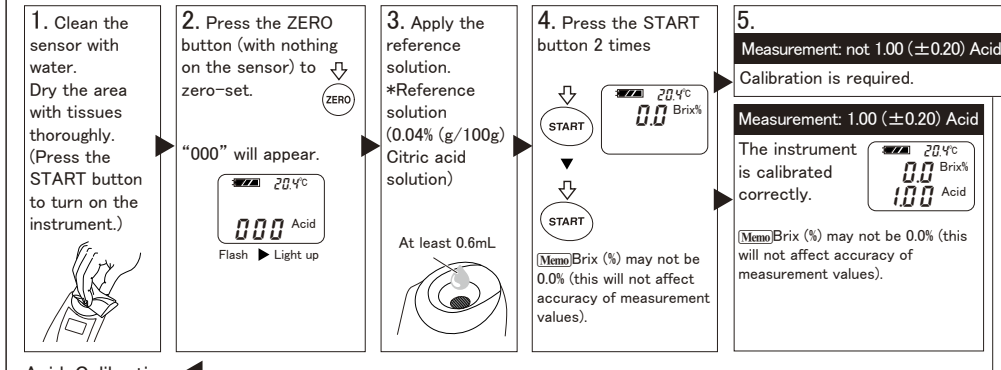

#### Acid: Calibration

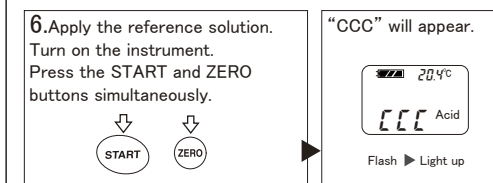

### Error Messages

The following messages alert the user when an operation has failed.

- Lo** The battery is low.
- RRR** Brix
  - The ZERO button was pressed with something other than water on the sensor section.
  - The sensor was not empty when zero-setting was attempted.
  - Calibration was attempted with something other than the calibration solution.
- LLL** Brix
  - The START button was pressed with nothing or an insufficient amount of sample on the sensor section.
  - Temperature
  - The sensor temperature is below the temperature range.
- HHH** Brix/Acid
  - The sample measured outside the measurement range
  - Temperature
  - The sensor temperature is above the temperature range.
- RRR** Brix
  - Too much light is entering the sensor, and the instrument cannot measure accurately. (Shade the sample stage with your hand and take a measurement again.)
- Sugar/Acidity Ratio
  - When the Sugar/Acidity Ratio is unable to be calculated.

## Acid: Offset Function

### Discrepancies with titration

Due to the difference in measurement principles, readings from the instrument may not match up exactly with the readings by titration for certain samples.

However, correlation between the two testing methods can be seen.

### Offset feature use

Create a conversion chart between the two testing methods.

$$y = a x + b$$

y: titration readings  
x: The instrument readings  
a: coefficient (multiplication)  
b: addition/subtraction number

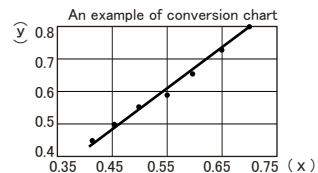

### For addition/subtraction (b) [Range: -5.00 to 5.00]

- Hold down ZERO while it is turned on. (At measured value displaying) "b" will appear.
- Press ZERO to select either addition (b) or subtraction (-b). No plus sign will be displayed.
- Press START to confirm. For addition, only "b" will appear.
- Enter the addition/subtraction number. The 1st digit: ZERO to change the number. START to confirm and move to the next digit. The 2nd digit: ZERO to change the number. START to confirm and move to the next digit. The 3rd digit: ZERO to change the number.
- Press START to confirm the addition/subtraction number. Next is to program a coefficient.

### For coefficient (a) [Range: 0.50 to 5.00]

- Enter the coefficient. The 1st digit: ZERO to change the number. START to confirm and move to the next digit. The 2nd digit: ZERO to change the number. START to confirm and move to the next digit. The 3rd digit: ZERO to change the number.
- Press START to confirm the coefficient.

For default Press the R button while setting up the Off-Set feature.

Factory default value

- The measurement range is shifted according to the offset settings.
- Screen images when offset is on



## Measurement Value

**Brix**  
Brix represents the weight of sucrose in 100 grams of sucrose solution as percentage by weight. When other dissolved solids are present in the solution, Brix conversion may be applied. Brix is a measure of the total dissolved solids in a solution and indicates the combined concentration of all soluble substances, such as sugar, salt, protein, and acids.

**Acid**  
This unit measures and determines the acidity through electrical conductivity. Chlorogenic acid is the primary acid found in coffee cherries. The instrument measures the total acidity in a sample and converts it into chlorogenic acid concentrations.

## Automatic Temperature Compensation

The Automatic Temperature Compensation (ATC) feature is based on temperature detected by the thermo sensor located near the sensor area. ATC may not work correctly when the temperature of the sensor area is not the same as the actual temperature of the sample. When measuring a hot or cold sample, let it sit on the sensor for approximately 20 seconds and measure, or take multiple readings until measurements become stable.

## Inserting Batteries

**Note** When the O-ring on the battery compartment cover is dirty or damaged, the water resistance may be compromised. Lubricate the O-ring regularly.

- Insert a coin in the groove on the battery compartment cover. Turn the coin counterclockwise to remove the cover.
- Insert batteries, observing the correct polarity.
- Align the cover and push it down.
- Close the battery compartment cover by pushing the cover in with a coin in the groove and turning it clockwise until it stops.

## About the Digital Scale

**Note** Remove the tape from the battery compartment.

### Contents

Main unit...1 Cover...2 (large and small) AAA batteries...2

### Parts

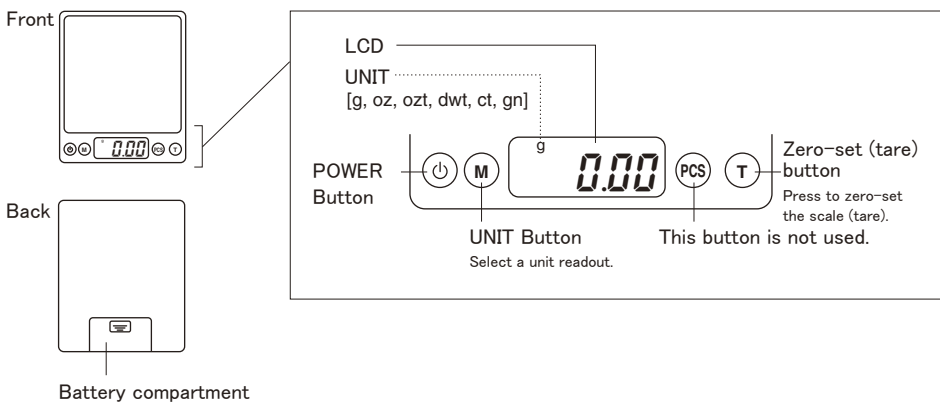

### How to Use the Digital Scale

- Press the POWER Button. "0" will appear.
- Check the unit readout. Press the UNIT button and select "g."
- Place the item you wish to weigh onto the scale. The item's weight will appear on the scale.

### Zero-setting and Weighing

- Press the POWER Button. "0" will appear.
- Place the beaker on the scale. The beaker's weight will appear on the scale.
- Press the Zero-set button (tare) "0" will appear.
- Pour the sample you wish to weigh into the beaker. The sample's weight will appear on the scale.

### Error Messages

Lo : The battery power is low. Replace with new alkaline AAA batteries.  
O-LD : The item you are trying to weigh exceeds the permissible weight limit of the scale. Quickly remove it from the scale.

### Environmental conditions

- Do not expose the scale to extreme heat or cold.
- Do not expose the scale to any type of moisture.
- Use between 10 to 30°C only.
- Use in a dry, clean environment.
- Any contact with or exposure to dust, debris, humidity, strong vibrations, extreme atmospheric conditions or other electronics may affect the accuracy of the scale and result in unreliable readings.

### Note

- For precise measurements, place the item you wish to weigh onto the scale gently.
- Place the scale atop a flat, stable surface.
- The digital scale is remarkably durable. However, it is a precision instrument and should be used and treated with the utmost care.
- Use of the scale for purposes other than its intended use will result in damage to its internal components.
- Do not shake or drop the scale.

### Specifications

Measurement range	0.01 to 500.00g
Resolution	0.01g
Unit	g, OZ, ozt, dwt, t, gn
LCD	LCD display with backlight
Auto-Off Feature	The scale will automatically turn off after 90 seconds of inactivity.
Power supply	Two (2) AAA alkaline batteries (Do not use rechargeable batteries.)
Temperature Conditions	Ambient temperature: 10 to 30°C

## Safety Precautions

Read and follow all safety instructions before operating the instrument.

### WARNING

- When measuring hazardous materials, use proper safety procedures, materials, and clothing to avoid personal injury. Anyone handling hazardous materials should understand its properties and its safety requirements.
- If the instrument is dropped or subjected to a strong impact, contact your supplier for inspection.
- Do not attempt to repair, modify, or disassemble the instrument.

### CAUTION

- Before use, carefully read the instruction manual and fully understand the function and operation for each part of the instrument.
- ATAGO is not liable for any loss and damage caused by the measurement and use of this instrument.
- If this instrument is used to measure highly acidic samples, the sensor section and sample stage may be damaged, resulting in inaccurate measurements.
- Do not use any metal tools when applying sample to the sensor section. The metal can damage the sensor section. If the sensor section is scratched or damaged, inaccurate measurements will occur.
- When the unit needs to be washed, use water at a temperature not exceeding 50°C.
- Only use the specified battery type. Observe proper polarities, properly aligning the anodes and cathodes.
- Do not leave the instrument in a location exposed to direct sunlight or near a heat source for any extended period of time.
- Do not change the ambient temperature of the instrument suddenly.
- Do not place the instrument where it will be subject to strong vibrations.
- Do not use the instrument where there are excessive amounts of dust.
- Do not store the instrument in an extremely cool area.
- Do not set or drop heavy objects on top of the instrument.
- Loosen the battery compartment cover for air transportation.
- The instrument is water-resistant, not waterproof, and should not be submerged.

## Storage and Maintenance

- Store the instrument in a dry place away from direct sunlight. Exposure to humidity may cause condensation inside, and exposure to direct sunlight may cause the plastic to warp.
- Do not use organic solvents (paint thinner, benzene, gasoline, etc.) on the plastic body case.
- Cleaning: Clean and dry the sensor area thoroughly after use, leaving no sample residues or water. (For oily samples:) Remove oily residues with mild soap, and then, rinse with water.
- Storage: Store the instrument away from direct sunlight at a stable temperature with as little fluctuation as possible.

## Repair and Warranty

The instrument is warranted for one year from the date of purchase. This warranty is void if the instrument shows evidence of the following. Send the included batteries as well if they are still in use.

- Having been disassembled by unauthorized personnel
- Damages to the sensor section and/or sample stage
- Water damage or having been dropped
- Having been misused and/or operated outside the environmental specifications
- Leakage from batteries other than those included with the unit

Repair services are available for a fee after the warranty expires. Contact an ATAGO authorized service center for service and support.

Please have the serial number information ready when contacting a service center.

## Specifications

Measurement range	Brix 0.0 to 60.0% Acid 0.10 to 1.90% 10.0 to 40.0°C	Automatic temperature compensation range	10 to 40°C
Resolution	Brix 0.1% Acid 0.01% 0.1°C	Ambient temperature range	10 to 40°C
Measurement accuracy	Brix ±0.2% Acid ±0.10% (0.10 to 1.00%) Relative precision ±10% (1.01 to 1.90%) ±1°C	Measurement time	Approx. 3 seconds
		Backlight	The backlight stays on for 30 seconds after any button is pressed.
		Power supply	Two (2) AAA alkaline batteries
		Battery life	Approx. 11,000 measurements (when using alkaline batteries)
		International Protection class	IP65
		Dimensions and weight	55(W) × 31(D) × 109(H)mm, 100g (main unit only)

The product is in conformity with the requirements of the EMC Directive 2004/108/EC.

**ATAGO CO., LTD.**  
Headquarters: The Front Tower Shiba Koen 23rd Floor 2-6-3 Shiba-koen, Minato-ku Tokyo 105-0011, Japan  
TEL: 81-3-3431-1943 FAX: 81-3-3431-1945  
overseas@atago.net http://www.atago.net/

**ATAGO INDIA Instruments Pvt. Ltd.**  
TEL: 91-22-28544915 / 40713232  
customerservice@atago-india.com

**ATAGO THAILAND Co., Ltd.**  
TEL: 66-21948727-9 66-21171549  
customerservice@atago-thailand.com

**ATAGO U.S.A., Inc.**  
11811 NE First Street, Suite 101, Bellevue, WA 98005 U.S.A.  
TEL: 1-425-637-2107 FAX: 1-425-637-2110  
customerservice@atago-usa.com

**ATAGO CHINA Guangzhou Co., Ltd.**  
TEL: 86-20-38108256  
info@atago-china.com

**ATAGO RUSSIA Ltd.**  
TEL: 7-812-777-96-96  
info@atago-russia.com

**ATAGO NIGERIA Scientific Co., Ltd.**  
TEL: 234-707-558-1552  
atagonigeria@atago.net

**ATAGO BRASIL Ltda.**  
TEL: 55 16 3913-8400  
customerservice@atago-brasil.com

**ATAGO ITALIA s.r.l.**  
TEL: 39 02 36557267  
customerservice@atago-italia.com

# twilight

INSTRUMENTOS DE MEDICIÓN INDUSTRIAL



LLÁMANOS

+52(81) 8115-1400 / +52 (81) 8173-4300

LADA Sin Costo:  
01 800 087 43 75

E-mail:  
[ventas@twilight.mx](mailto:ventas@twilight.mx)

[www.twilight.mx](http://www.twilight.mx)



/ [twilightsadecv](#)



/ [twilightsadecv](#)



/ [twilightsadecv](#)