

# twilight

INSTRUMENTOS DE MEDICIÓN INDUSTRIAL

## Refractometro en Linea AT-CM800a

[www.twilight.mx](http://www.twilight.mx)

 / [twilightsadecv](https://www.facebook.com/twilightsadecv)

 / [twilightsadecv](https://twitter.com/twilightsadecv)

 / [twilightsadecv](https://www.youtube.com/twilightsadecv)

IN-LINE BRUX-MONITOR  
**CM-800 $\alpha$**

**Instruction Manual**

Cat.No..3564

# CONTENTS

1.Precautions for Use .....	2
2.Refractive Index and Brix(%) .....	8
(1)What is refractometer? .....	8
(2)What is the Refractive Index? .....	8
(3)Brix(%) scale .....	8
(4)Temperature correction .....	8
3.Unpacking and Installation .....	9
(1)Configuration .....	9
(2)Unpacking .....	10
(3)Installation .....	10
4.Names and Functions of Components .....	11
(1)CM-800 $\alpha$ .....	11
(2)Operation Display .....	12
(3)AC Adapter AD-32, AD-33 or AD-34 (Optional) .....	12
5.Mounting the CM-800 $\alpha$ and AC adapter AD-32 (AD-33 or AD-34) (Optional) .....	13
6.Mounting the Sample Inlet Unit .....	14
(1) Installation of the CM-800 $\alpha$ with the sample inlet unit (optional): .....	14
(2) Installation of the CM-800 $\alpha$ without the sample inlet unit (optional): .....	16
7.Connecting the Power Cable or AC Adapter AD-32 (AD-33 or AD-34) (Optional) .....	17
(1)When the CM-800 $\alpha$ is used alone .....	17
(2)When the AC adapter AD-32, AD-33 or AD-34 (Optional) is used .....	18
8.External Output .....	19
(1)Recorder output .....	19
(2)RS-232C output .....	20
9.Power Supply .....	22
(1)When the CM-800 $\alpha$ is used alone .....	22
(2)When the AC adapter AD-32, AD-33 or AD-34 (optional) is used .....	22
10.Measuring Brix(%) .....	23
11.Setting the Measurement Interval and Mode-S Level & Changing the Number of Decimal Places Displayed .....	24
(1)Setting the Measurement Interval and Mode-S Level .....	24
(2)Changing the Number of Decimal Places Displayed .....	24
12.Adjusting to the Reference .....	25
13.Setting the Temperature Correction Values .....	26
14.Setting the Recorder Output .....	30
15.Cleaning the Prism .....	32
16.Error Codes & Troubleshooting .....	33
17.Consumable Parts and Optional Items .....	34
(1)Consumable Parts .....	34
(2)Optional Items .....	34
18.Relationships between Brix(%) Values and Refractive Index (nD) Values .....	35
19.Specifications .....	36
20.Dimensions .....	37
21.Repair Service and Warranty Period .....	38
22.ATAGO CO.,LTD. Service Centers .....	39

# 1. Precautions for Use

## Introduction

Thank you for purchasing the CM-800 $\alpha$  In-line Brix-Monitor.

Before using your CM-800 $\alpha$ , read this instruction manual carefully, and keep it on hand for future reference.

For safe use --- Be sure to observe the following.

To prevent injury and damage to property, safely operate the CM-800 $\alpha$  by observing the precautions outlined in this manual.

The explanation of the indications and symbols of the precautions are as follows.

Read and understand them before continuing on to the following pages.

## Explanation of indications



### WARNING

If this indication is neglected and the instrument is handled incorrectly, serious injury or death may result.



### CAUTION

If this indication is neglected and the instrument is handled incorrectly, injury and/or property damage may result.

## Explanation of symbols



This symbol denotes an item of which to be warned or cautioned.

The contents of warning are described in detail in or near the  $\Delta$ .



This symbol denotes an action that must not be performed (a prohibited item).

The contents of prohibition are described in detail in or near the  $\bigcirc$ .



This symbol denotes an action that must be performed.

The contents of instruction are described in detail in or near the  $\bullet$ .

## Handling of this instrument



### WARNING

◇When measuring a substance harmful to the human body, be aware of its properties and wear protective gloves, mask, etc.



◇Immediately turn off the power (DC24V) if the unit begins to overheat, smoke or emit an abnormal smell. If the AC adapter AD-32, AD-33 or AD-34 (optional) is used, remove the power cable plug from the AC 100-240V outlet. Fire or malfunction may result if the instrument continues to be used. Contact your ATAGO Distributor for an inspection.



◇Do not attempt to repair, modify, or disassemble the instrument yourself.

Improper servicing may result in fire, electrical shock, or burns.



◇If the instrument is dropped or is subjected to a strong shock, have it inspected by an Authorized ATAGO Service Center.

Fire or malfunction may result if the instrument is used.



### CAUTION

◇Do not apply water or sample to any part of the instrument other than the surface of the prism.

Applying water to any other part of the instrument may result in a malfunction.



◇Do not measure very hot or highly acidic samples.

This may damage the prism, which would result in inaccurate measurements.



Handling of this instrument (Continued)



CAUTION

- ◇DO NOT measure any sample that can damage the prism or the sample inlet unit.
- ◇Sample temperature should be kept between 5°C and 100°C when the power is turned on.
- ◇Cleaning liquids up to 150°C can be used for CIP or SIP. The cleaning liquid can be used safely for 30 minutes at one time. The momentary difference between the sample liquid temperature and the cleaning liquid temperature must be no more than 80°C.  
When using cleaning liquids at temperatures over 150°C, the power source (DC24V) must be turned off. If the AD-32 (AD-33 or AD-34) is used, unplug from the outlet before cleaning.
- ◇The lower limit value of wetted parts temperature is -30°C.



- ◇ If the sample could possibly stain the prism, immediately clean the prism according to the procedure described on page 32 "15. Cleaning the Prism".



- ◇The CM-800 $\alpha$  power (DC24V) should be turned off when it is not to be used for a long period of time. If the AD adapter AD-32, AD-33 or AD-34 (optional) is used, disconnect the power cable plug from the AC 100-240V outlet.



- ◇When transporting the instrument, pack it in the original box.
- ◇When transporting by aircraft, disconnect the power (DC24V) cable or the DC output cable of the AC adapter AD-32, AD-33 or AD-34 (optional) from the power input terminal of the CM-800 $\alpha$ .



- ◇Carefully read this instruction manual and fully understand the function and operation of each part of the instrument before use.
- ◇Check that each part of the instrument operates normally before use.
- ◇Perform the necessary inspections and reference adjustments according to the instruction manual.
- ◇The manufacturer shall not be held responsible for any damage that results from using the instrument for other than its intended purposes (measurement of Brix(%), sugar content, liquid concentration).
- ◇The manufacturer shall not be held responsible if the use of the instrument has an undesired effect on the measured materials.
- ◇The prism in contact with the sample is a consumable item.

## Handling of plug



### WARNING

- ◇ Supply the CM-800 $\alpha$  with DC24V only (allowable fluctuation is  $\pm 10\%$ ).  
Short-circuit, smoke, or fire may occur if other voltages are used.
- ◇ The AC adapter AD-32 (AD-33 or AD-34) plug must be inserted into an AC 100-240V outlet. Other outlets may result in a short circuit, smoke, or fire.
- ◇ Do not use a power cable and plug that is damaged, cut, broken, or altered.  
Use may result in fire, electrical shock, or burn.  
For repair service of the power cable and plug, contact an Authorized ATAGO Service Center.
- ◇ Do not cut a plug to extend the power cable of the AD-32 (AD-33 or AD-34).



### CAUTION

- ◇ Do not insert or pull out the connector and plug with wet hands.
- ◇ When disconnecting the power cable of the AC adapter AD-32, AD-33 or AD-34 (optional) from the AC 100-240V outlet, remove by pulling on the plug only.  
Pulling the cable may damage it, and could result in fire or electrical shock.



- ◇ Connect the grounding wire when connecting the plug of the power cable of the AC adapter AD-32, AD-33 or AD-34 (optional) to the AC 100-240V outlet.



Connection of optional component (printer, etc.)



WARNING

◇ Turn off the power (DC24V) prior to connecting cables to the individual units. If the AC adapter AD-32, AD-33 or AD-34 (optional) is used, pull out the power cable plug from the AC100-240V outlet before connecting.  
Connecting the cables while the power is on may result in electrical shock.





## Conditions to be observed when using

### Environmental conditions

- ◇ Use the instrument at an altitude below 2,000m (above sea level).
- ◇ Use the instrument indoors.
- ◇ Use the instrument where the temperature is between 5 to 40°C.
- ◇ Do not leave the instrument in a location exposed to direct sunlight or near a heating unit where the temperature may rise.
- ◇ Do not change the environmental temperature of the instrument suddenly.
- ◇ Do not place the instrument in a place where it may be subject to strong vibrations.
- ◇ Do not use the instrument where there is much dust.
- ◇ Do not leave the instrument where the temperature is extremely low.
- ◇ Do not leave the instrument in a damp place.
- ◇ Do not place or drop heavy objects on the instrument.
- ◇ Use this instrument under the condition where humidity is 80% at 31°C or lower, falling linearly to 50% at 40°C.
- ◇ Main supply voltage fluctuation should not to exceed  $\pm 10\%$  the nominal voltage.
- ◇ Installation categories (Overvoltage Categories): II
- ◇ The pollution degree is 2 (according to IEC60664).

### Handling

- ◇ Do not drop the instrument or subject it to any strong shock.
- ◇ The power cable may be damaged by:
  - Bending the cable.
  - Pulling the cable.
  - Twisting the cable.
  - Placing the cable under heavy objects.
  - Catching the cable between objects.

### Daily maintenance

- ◇ If the instrument becomes dirty, wipe it with a soft cloth.
- ◇ Do not use benzine, paint thinner, etc. to clean the instrument.

## 2. Refractive Index and Brix(%)

The In-line Brix-Monitor CM-800 $\alpha$  is a refractometer that detects the Refractive Index of a sample and outputs the Brix(%) value on the display.

The CM-800 $\alpha$  can also transmit measured data to external devices via 4 to 20mA or RS-232C.

### (1) What is refractometer?

When a straw is placed into a glass filled with water, the straw appears to bend. When a straw is placed into a glass filled with sugar water, the straw appears to bend much more sharply than in the case of water alone.

This phenomenon is known as the refraction of light. The refractometer is an instrument that measures the Refractive Index by utilizing this principle (the Refractive Index increases in proportion to the concentration of the solution), and was developed by Dr. Ernst Abbe at the end of the 19th century.

### (2) What is the Refractive Index?

If the Refractive Index of air under atmospheric pressure is 1, then when light enters medium  $\chi$ , the ratio of the sine of the incident angle  $\alpha$  measured against the phase boundary to the sine of the refracting angle  $\beta$  is called the Refractive Index of the medium  $\chi$ .

The Refractive Index varies with the wavelength of light and temperature and is represented as follows:

$$n_D^t$$

n : Represents the Refractive Index  
t : Temperature (°C)  
D : D-line of sodium (589nm)

For example, Refractive Index of water at 20°C under the D-line is:

$$n_D^{20} = 1.33299;$$

(Generally expressed as  $n_D = 1.33299$ .)

**Note** The Refractive Index is based upon the supposition that the Refractive Index in a vacuum is 1 and is called the absolute Refractive Index. Generally, however, this index is seldom used.

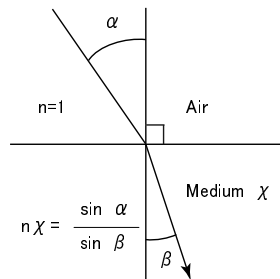

### (3) Brix(%) scale

The CM-800 $\alpha$  is programmed with the Brix(%) scale, based on the Refractive Index of water ( $n_D = 1.33299$ ) as the reference (0%). The Brix(%) scale represents the weight of sucrose expressed by percentage (sucrose weight in grams contained in 100 grams of sucrose solution).

Therefore, this scale corresponds with the sucrose concentration. However, most samples are comprised of ingredients other than sugar. The total concentration of these ingredients is represented by the Brix(%), so this makes the Brix(%) scale a practical tool for measuring concentrations.

**Note** The Brix(%) scale is recommended by ICUMSA (International Committee of Uniform Method of Sugar Analysis) and is expressed in % mas (Sucrose) in international units (SI unit).

The relationship between Brix(%) and the Refractive Index ( $n_D$ ) is outlined on page 35.

### (4) Temperature correction

The Refractive Index of a substance varies with temperature. Thus, when using a refractometer to measure the Refractive Index of a liquid, the measurement value will vary with the sample temperature.

The CM-800 $\alpha$  always detects the prism temperature. The value of the measurement is automatically corrected for temperature by a built-in processor, so that the displayed value is equal to the value measured at 20°C (provided that the sample temperature is within the range of 5 to 100°C).

### 3. Unpacking and Installation

#### (1) Configuration

The CM-800 $\alpha$  is comprised of the items listed below.

- ① Main unit of the In-line Brix-Monitor CM-800 $\alpha$ .
- ② through ⑥ are optional items and are included with the main unit if ordered. Additional items can be ordered at any time. For details, please contact an Authorized ATAGO Distributor.

① In-line Brix-Monitor CM-800 $\alpha$  (Cat.No.3564)

- CM-800 $\alpha$  main unit
- Power (DC24V) cable: approx. 1m
- Instruction manual (this book)
- Inspection certificate

② AC adapter AD-32 (Cat.No. 3527), AD-33 (Cat.No. 3528) or AD-34 (Cat.No. 3529)

The AD-32 is an adapter that converts AC 100V to DC24V for supplying power to the CM-800 $\alpha$ .

The AD-33 is an adapter that converts AC 110V to DC24V for supplying power to the CM-800 $\alpha$ .

The AD-34 is an adapter that converts AC 220-240V to DC24V for supplying power to the CM-800 $\alpha$ .

③ Sample inlet unit

IDF/ISO clamp union (ferrule), IDF/ISO screw union (screw), JIS Flange, small diameter series compression fitting and hose connector are available. Refer to page 34 "17. Consumable Parts and Optional Items".

④ Recorder output cable

- 5 meters (Parts No.RE-5635)
- 10 meters (Parts No.RE-5636)
- 15 meters (Parts No.RE-5638)
- 20 meters (Parts No.RE-5639)

⑤ RS-232C cable

- 15 meters
  - D-sub 9pin (Parts No. RE-65330)      D-sub 25pin (Parts No. RE-5677)
- 1 to 15 meters
  - D-sub 9pin (Parts No. RE-65331)      D-sub 25pin (Parts No. RE-5647)

⑥ Stand (RE-8607) for mounting the CM-800 $\alpha$  main unit and the AD-32 (AD-33 or AD-34)

- Stand
- Hexagonal-head bolts (M6×10) ..... 8
- Spring washers ..... 8
- Washers ..... 8

## (2) Unpacking

- ① Unpack the CM-800 $\alpha$  and confirm that there is no external damage.
- ② Confirm that all parts of the main unit, accessories, and any optional units as described in section “(1) Configuration” (👉 page 9) are included.

## (3) Installation

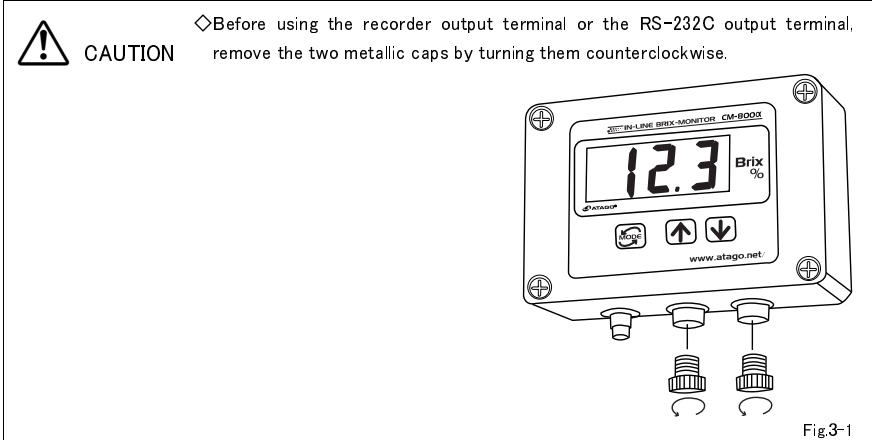

- ① Connect the CM-800 $\alpha$  to an AC100-240V main outlet (voltage fluctuations not to exceed 10%), 50/60Hz with the power cable.
- ② The CM-800 $\alpha$  should be supplied with DC24V (allowable fluctuation is  $\pm 10\%$ ).  
The AC adapter AD-32, AD-33 or AD-34 (optional) should be connected to a power supply of AC 100-240V, 50/60 Hz.
- ③ The CM-800 $\alpha$  should be installed in a location with an ambient temperature of 5 to 40°C.
- ④ Because the CM-800 $\alpha$  incorporates highly precise components, DO NOT install in locations exposed to direct sunlight or near a heating source, or in an environment that is dusty or exposed to corrosive gasses.
- ⑤ The CM-800 $\alpha$  should be installed in a location that is free from vibration. When installing, take special care to avoid any strong shock to the instrument.

## 4. Names and Functions of Components

### (1) CM-800 $\alpha$

#### ① Prism

Corrosion resistant optical glass, with a polished surface to reflect light.

#### ② Prism stage

Connected to the sample inlet and fastened by a clamp band.

#### ③ Radiator

Disperses heat when measuring high temperature samples to prevent the electric circuit from overheating.

#### ④ Mounting screw locations

Used to mount the CM-800 $\alpha$  to the stand.

#### ⑤ Operation display

Comprised of the operation keys and display

☞ “(2) Operation Display” page 12

#### ⑥ Power (DC24V) input terminal

Terminal to connect the power cable (for DC24V input) or the DC output cable of the AC adapter AD-32, AD-33 or AD-34 (optional)

#### ⑦ RS-232C output terminal

Terminal to connect to a computer.

#### ⑧ Recorder output terminal

Terminal to connect to a recorder.

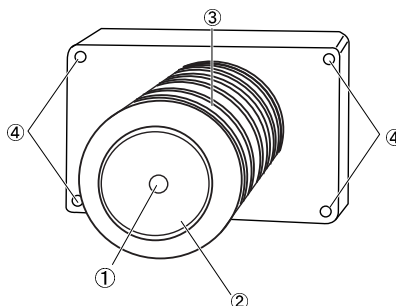

Fig.4-1

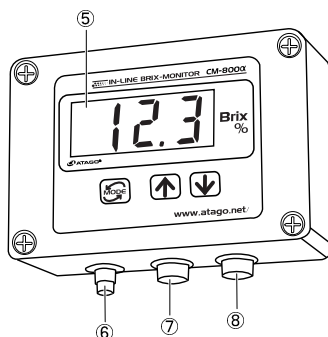

Fig.4-2

## (2) Operation Display

### ① Measurement value display

Digitally displays the measurement value [Brix(%)], setting mode, and other setting values.

### ② MODE key

Switches or sets the display mode of the measurement value and the setting mode.

Setting mode number	Setting description
[0]	Measurement Interval and Mode-S Level
[1]	Adjustment to the reference
[2]	Temperature correction factor
[3]	Recorder output, lower limit value
[4]	Recorder output, upper limit value
[5]	Changing the Number of Decimal Places Displayed

### ③ Up and down keys

Increase or decrease the value in each setting mode.

The down  key also switches the display of each setting mode.

The temperature is displayed when press the down  key while measuring a sample.

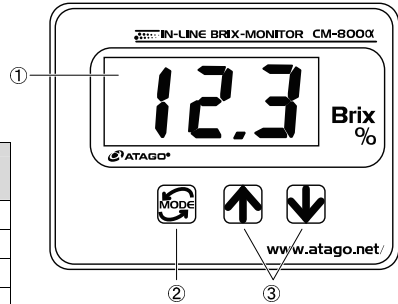

Fig.4-3

## (3) AC Adapter AD-32, AD-33 or AD-34 (Optional)

### ① Power cable

Connects to the AC 100-240V outlet.

### ② DC output cable

Connects to the output DC24V.

### ③ Pilot lamp

Functions when AC 100-240V is being input and DC24V is being output.

### ④ Mounting screw holes

These holes are used to mount the AD-32, AD-33 or AD-34 to the stand.

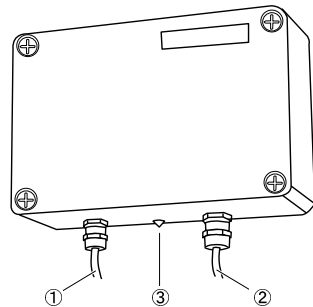

Fig.4-4

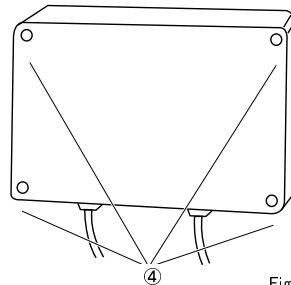

Fig.4-5

## 5. Mounting the CM-800α and AC adapter AD-32 (AD-33 or AD-34) (Optional)



### WARNING

◇ Turn off the power (DC24V) before mounting. If AD-32 (AD-33 or AD-34) is used, disconnect the power cable's plug from the AC 100-240V outlet before beginning. Electrical shock may occur if the unit is mounted with the power connected.

#### ① Mounting screws (Fig.5-1, Fig.5-2)

The CM-800α and the AD-32 (AD-33 or AD-34) each have four mounting screw locations.

Use the screws supplied with the stand to mount the CM-800α and AD-32 (AD-33 or AD-34) on the stand or panel plate.

The depth of the screw locations is 10mm, M6.

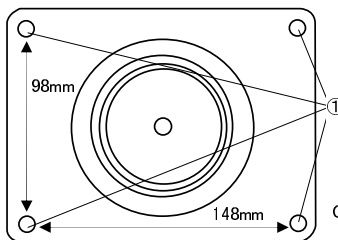

CM-800α  
Fig.5-1

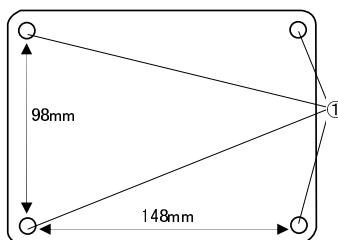

AD-32 AD-33 or AD-34  
Fig.5-2

Example of screw configuration (Fig.5-3)

- ① CM-800α or AD-32 (AD-33 or AD-34)
- ② Washer (M6)
- ③ Spring washer (M6)
- ④ Hexagonal-head bolt M6 × 10

**Note** Hexagonal-head bolts, spring washers and washers are included as standard accessories with the stand (optional).

**memo** Length of the hexagonal-head bolt =  
(Screw hole depth, 10mm) + (Panel plate length)

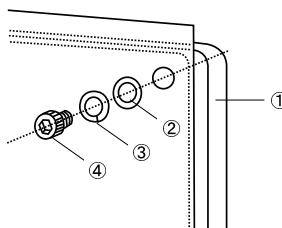

Fig.5-3

Mounting on a stand (optional) (Fig.5-4)

For information on ordering a stand, see page 34.

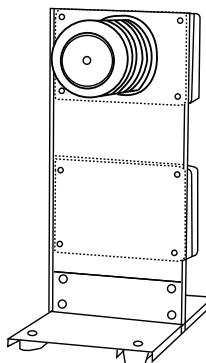

Fig.5-4

## 6. Mounting the Sample Inlet Unit



### WARNING

◇ Turn off the power (DC24V) before mounting. If AD-32 (AD-33 or AD-34) is used, disconnect the power cable's plug from the AC 100-240V outlet before beginning. Electrical shock may occur if the unit is mounted with the power connected.



### CAUTION

◇ Ensure that the prism is clean and free of any damage and/or scratches. Completely remove any sample before installing the CM-800 $\alpha$  to piping or equipment

(1) Installation of the CM-800 $\alpha$  with the sample inlet unit (optional):

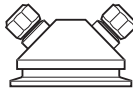

Compression Fitting

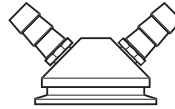

Hose connector



Straight type

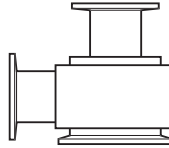

L type

Fig.6-1



## Mounting procedure

- ① Install the CM-800 $\alpha$  so that the prism surface is at a right angle to the ground.
- ② Attach the sample inlet unit to the CM-800 $\alpha$  with O-ring (accessory) inserted between them, and fasten them together with the clamp band (accessory).
- ③ Install the inlet unit so that the sample solution runs from the lower nozzle to the upper nozzle to prevent air bubbles from forming.
- ④ When connecting the tubes to the hose connector, clamp them with a tie band.
  - ☞ "Use of tie bands" page 16
- ⑤ The prism surface may become contaminated with solids, dirt and/or grease. If this happens, the prism surface must be cleaned by hand.
  - ☞ "15. Cleaning the Prism" page 32

The sample inlet unit should be installed in such a manner that it can be easily removed to allow access to the prism for cleaning.

**memo** Suspending the CM-800 $\alpha$  (2.3kg) when using the sample inlet unit to connect to the piping is dangerous.

Use of the optional stand is recommended.

☞ "5. Mounting the CM-800 $\alpha$  and AC adapter AD-32 (AD-33 or AD-34) (Optional)" page 13

☞ "17. Consumable Parts and Optional Items" page 34

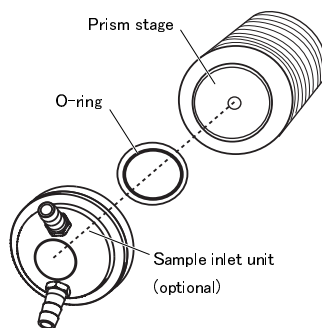

Fig.6-2

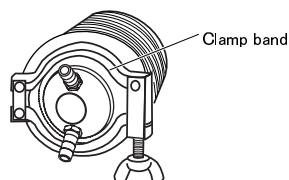

Fig.6-3

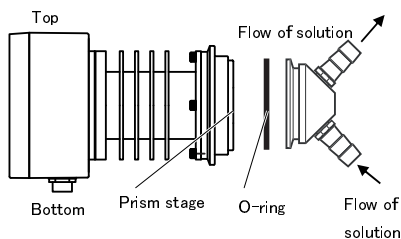

Fig.6-4

● Use of tie bands (Hose connector (RE-67501) only)

The hose connector (RE-67501) comes with tie bands as shown in Fig.6-5.

- ① Insert an end of tube onto the nozzle so that the tube is tightly put on the nozzle.
- ② To fasten the tube with the tie band, insert the tip of the tie band into the slot (Fig.6-6).
- ③ While holding the tie band by the part A, pull the tip (B) of the tie band to tighten it (Fig.6-7).
- ④ After tightening the tie band, cut the tie band by the part C for cutting off the extra (Fig.6-8).

**Note** The tie band that were tightened once cannot be reused.

For removing the tie band from the tube, cut it.

For fastening the tube with a tie band again, use a new tie band.

**Note** The tie bands are made of plastic. If measuring chemicals that are corrosive to plastic, use tie bands made of an alternative material.

**memo** Tie bands can be ordered through your ATAGO Distributor.

 "17. Consumable Parts and Optional Items"  
page 34



Fig.6-5

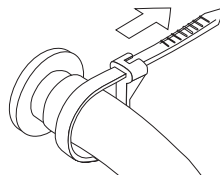

Fig.6-6

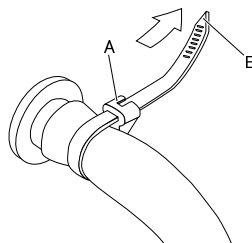

Fig.6-7

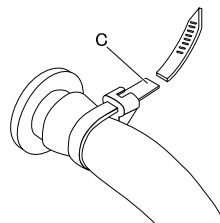



Fig.6-8

(2) Installation of the CM-800 $\alpha$  without the sample inlet unit (optional):

Please note the following when installing the CM-800 $\alpha$  to piping or equipment without using a sample inlet unit (optional):

- ① The size of the prism stage of the CM-800 $\alpha$  is a 3S ferrule. The ferrule connection is recommended for installation.
- ② Install the CM-800 $\alpha$  so that the prism surface is at a right angle to the ground.
- ③ Connect the unit to the piping so that the sample flow directly contacts the prism surface. The direct flow of samples (and self cleaning solutions) in contact with the prism will keep substances from adhering to the prism surface.
- ④ When installation to a solution tank is preferred, allow the sample flow to directly contact the prism surface.
- ⑤ The sample solution must remain in the temperature range of 5 to 100°C.
- ⑥ During operation, build up of solids, dirt and/or grease may form on the prism surface. When this occurs, the prism surface must be manually cleaned ( "15. Cleaning the Prism" page 32).

For ease of cleaning, the CM-800 $\alpha$  should be installed in such a manner so that the unit can be easily removed from the piping or solution tank.

## 7. Connecting the Power Cable or AC Adapter AD-32 (AD-33 or AD-34) (Optional)



### WARNING

◇ Turn off the power (DC24V) when connecting or disconnecting the power cable (for DC24V) or the DC output cable of the AD-32 (AD-33 or AD-34) to or from the terminal. When AD-32 (AD-33 or AD-34) is used, remove the power cable plug from the AC 100-240V outlet.



### CAUTION

◇ Disconnect the power cable or the DC output cable of the AD-32 (AD-33 or AD-34) from the power input terminal of the CM-800 $\alpha$  when transporting the CM-800 $\alpha$  by aircraft.

### (1) When the CM-800 $\alpha$ is used alone

- ① Connect the power (DC24V) input cable connector (provided) to the power (DC24V) input terminal located at the bottom of the CM-800 $\alpha$ .

Connect the opening of the input terminal with the connector pin and insert the connector. Then fasten the connector by turning the connector ring clockwise. To disconnect the power cable, fully turn the connector ring counterclockwise and remove the connector.

- ② Connect the power (DC24V) input cable terminal to the power supply of DC24V as illustrated in Fig.7-1.

**Note** At this stage, keep the DC24V power off.

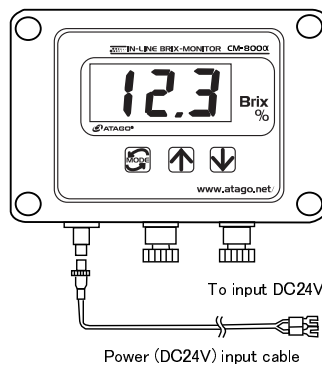

Fig.7-1

Power (DC24V) input cable and code information table.

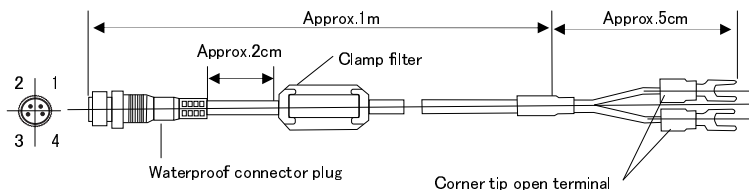

Fig.7-2

Pin No.	Code color	
3	Brown	+24V
4	Blue	GND

(2) When the AC adapter AD-32, AD-33 or AD-34 (Optional) is used

Attach the connector of the DC output cable of the AD-32 (AD-33 or AD-34) to the power (DC24V) input terminal at the bottom of the CM-800  $\alpha$ .

Connect the opening of the input terminal with the connector pin and insert the connector. Then turn the connector ring clockwise to fasten the connector.

To disconnect the DC output cable, fully turn the connector ring counterclockwise and remove the connector.

**Note** At this stage, keep the plug disconnected from the AC 100–240V outlet.

**Note** When AD-32 (AD-33 or AD-34) is used, the power (DC24V) input cable provided with the CM-800  $\alpha$  is not used.

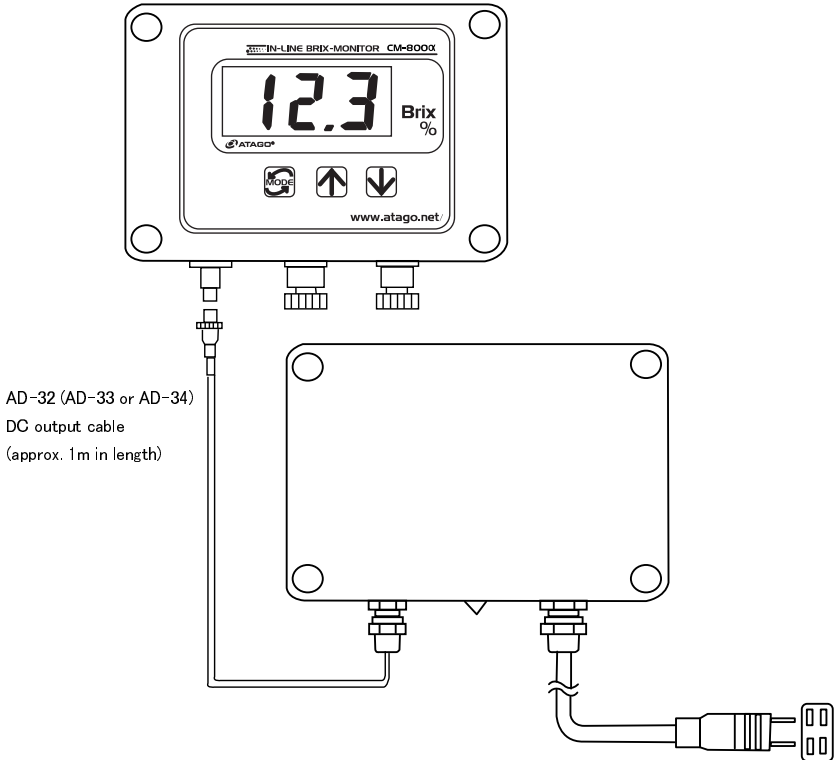

Fig.7-3

## 8. External Output



### WARNING

◇When connecting or disconnecting the Recorder Output Cable or RS-232C Cable to the CM-800 $\alpha$ , be sure to turn off the power (DC24V). If AD-32 (AD-33 or AD-34) is used, be sure to remove the plug from the outlet before connecting these cables.

The CM-800 $\alpha$  comes equipped with external outputs for a 4 to 20mA recorder and a RS-232C.

### (1) Recorder output

The Recorder Output provides a 4 to 20mA signal of the Brix(%) (open-circuit voltage is approx. 5V).

The Brix(%) range to be output through the 4 to 20mA signal is set as described in Chapter 14 "Setting the Recorder Output." (See page30.)

To utilize the 4 to 20mA signal, connect the Recorder Output Cable (optional) to the Recorder Output terminal on the CM-800 $\alpha$ .

Recorder output cable and code table

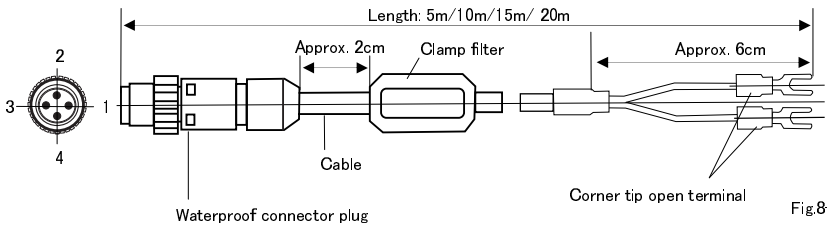

Fig.8-1

Pin No.	Code color	Polarity
1	Red	+
2	Black	-

## (2) RS-232C output

The CM-800 $\alpha$  features a RS-232C output for computers. The RS-232C cable is an optional accessory. When using the RS-232C cable, the CM-800 $\alpha$  and the PC should be separated by no more than 15 meters.

### ① RS-232C output cable and code tables (Fig.8-2)

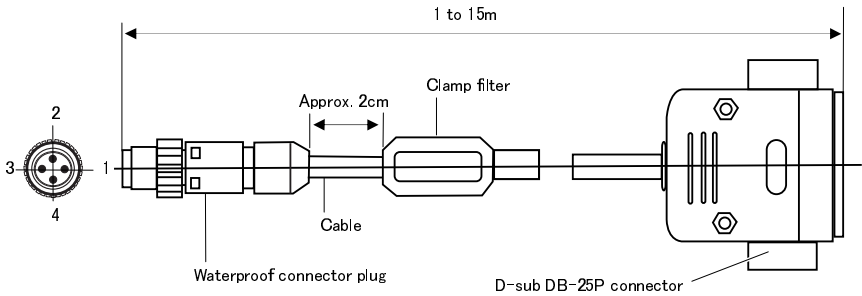

Fig.8-2

Pin No.	Code color
1	Black
2	Black/Silver
3	Red
4	Shield

Pin No.	Code color	Signal name
2	Black/Silver	TXD
3	Black	RXD
4	Fold	
5		
7	Red	S.GND
1	Shield	F.GND

### ② Communications parameters

BAUDRATE : 2400bps  
 DATA LENGTH : 7bits  
 PARITY : Even  
 STOP BIT : bit 1

③ Transmit data

Output format of RS-232C is as follows.

Fixed range(No zero suppression) : ○○.○○.△△△.△.☆.☆☆☆☆☆ CR / LF

○○.○○ : Brix(%)

The Brix(%) display range is “-2.00 to 80.50”.

Example

Display	Brix(%)
06.30	6.30
25.00	25.0
LL.LL	-2.01 or less
HH.HH	80.51 or higher
EEEE	Error

△△△.△ : Temperature

The temperature display range is “-00.5 to 130.0”.

Example

Display	Temperature
-00.6	-0.6°C or less
023.5	23.5°C
120.0	120.0°C
130.0	130.1°C or higher

☆☆☆☆☆ : Refractive index

Display	Refractive index
LL.LL	L.LLLLL
HH.HH	H.HHHHH
EEEE	E.EEEEE

## 9. Power Supply



### WARNING

- ◇ NEVER connect the CM-800 $\alpha$  to power other than DC24V (allowable fluctuation is  $\pm 10\%$ ).
- ◇ NEVER insert the plug of the AD-32 (AD-33 or AD-34) AC Adapter to an outlet other than AC 100-240V.
- ◇ NEVER use a power cable that is damaged, cut, broken, or altered. Fire, electrical shock or burns may occur.  
To purchase replacement power cables, contact an Authorized ATAGO Distributor.



### CAUTION

- ◇ NEVER plug the AD-32 (AD-33 or AD-34) AC Adapter in with wet hands.
- ◇ When disconnecting the power cable from an AC 100-240V outlet, be sure to remove by pulling the plug.  
Pulling by the cable may damage the cable and cause fire or electrical shock.
- ◇ When connecting the AC Adapter AD-32 (AD-33 or AD-34) to an outlet, be sure to connect the ground.

**Note** The CM-800 $\alpha$  has no power switch. When power is supplied to the CM-800 $\alpha$ , the measurement value display illuminates and the Brix(%) measurement commences.

### (1) When the CM-800 $\alpha$ is used alone

- ① Confirm that the power (DC24V) input cable is properly connected to the CM-800 $\alpha$  and the DC24V power supply.
- ② When the DC24V power is supplied, the CM-800 $\alpha$  turns on and the measurement value display will illuminate.

### (2) When the AC adapter AD-32, AD-33 or AD-34 (optional) is used

- ① Confirm that the CM-800 $\alpha$  and the AD-32 (AD-33 or AD-34) are properly connected.
- ② When the AD-32 (AD-33 or AD-34) power cable is plugged into an outlet, the CM-800 $\alpha$  turns on and the measurement value display will illuminate.  
When the AD-32 (AD-33 or AD-34) is connected to an outlet and the DC24V is output, a lamp will illuminate on the bottom of the AC Adapter.



## 10. Measuring Brix(%)



### WARNING

- ◇ If the unit begins to overheat, smoke, or emit an abnormal smell, immediately turn off the power and unplug the unit from the power supply.  
If this happens, please discontinue use of the CM-800 $\alpha$  and contact an Authorized ATAGO Distributor to assist with inspection and/or repair. Continued use may cause fire or a malfunction of the unit.
- ◇ NEVER repair, modify, or disassemble the CM-800 $\alpha$ . Fire, electrical shock or burns may occur.
- ◇ If the CM-800 $\alpha$  is dropped or receives a severe impact, DO NOT use it and ask an Authorized Service Center to inspect it.  
Continued use may cause smoke or fire.



### CAUTION

- ◇ DO NOT measure any sample that can damage the prism or the sample inlet unit. Sample temperature should be kept between 5°C and 100°C when the power is turned on.
- ◇ Cleaning liquids up to 150°C can be used for CIP or SIP. The cleaning liquid can be used safely for 30 minutes at one time. The momentary difference between the sample liquid temperature and the cleaning liquid temperature must be no more than 80°C.  
When using cleaning liquids at temperatures over 150°C, the power source (DC24V) must be turned off. If the AD-32 (AD-33 or AD-34) is used, unplug from the outlet before cleaning.
- ◇ The lower limit value of wetted parts temperature is -30°C.
- ◇ If the sample solution could potentially stain the prism, immediately clean the prism after measurement (following the instructions on page 32 of this instruction manual).

① When power is supplied to the CM-800 $\alpha$ , the Brix(%) measurement starts.

**Note** The CM-800 $\alpha$  has no power switch.



② The Brix(%) value will be displayed when sample flows onto the prism surface.

③ If there is no sample on the prism surface (only air), the error message [L.L.L.] will be displayed.

④ The CM-800 $\alpha$  constantly detects the temperature of the prism. When the sample temperature is within the range of 5 to 100°C, the Brix(%) values are automatically compensated for temperature.

**memo** When the CM-800 $\alpha$  was shipped from the factory, the temperature correction values for sucrose are set as default.

 To change temperature correction values, see page 26

⑤ While the Brix(%) is displayed, press and hold the down  key to display the prism temperature. For example, if the temperature of the prism is 20°C, the display will indicate "20c". When the down  key is released, the display will switch to the Brix(%).

**memo** When the temperature is in the range of 100 to 130°C, the temperature will be displayed as follows:  
"100" when it is 100°C; and "125" when it is 125°C.

⑥ For calibration (adjustment to a reference solution) see page 25.

For the setting the Recorder Output see page 30.

**Note** If an error message is displayed, refer to page 33 for the appropriate action.

# 11. Setting the Measurement Interval and Mode-S Level & Changing the Number of Decimal Places Displayed

## (1) Setting the Measurement Interval and Mode-S Level

The Mode-S feature is designed to improve the measurement stability of samples that may have conventionally resulted in fluctuating readings.



① Turn on the power (24V DC) according to the instructions on page 22, "9. Power Supply"

The unit will display the real-time measurements in Brix(%).



② Hold down the  key for one second.

Once [0] appears, press the  key.

"c - #" will appear, wherein " #" denotes a number from 1 to 5.

③ Use the  and  keys to select an interval.

Press the  key to confirm the selection. "d - #" will appear, wherein " #" denotes a number from 1 to 5.

④ Use the  and  keys to select a Mode-S level.

Press the  key to confirm the selection, and [0] will appear.

⑤ Each time the  key is pressed, the menu item displayed switches in the order of: [1], [2], [3], [4], [5], and Brix(%). Select Brix(%).

### ● Measurement interval: "c - #"

There are 5 options of intervals at which the unit takes measurements. The factory default is the shortest interval "c-1" wherein measurements are taken every 1.6 to 1.7 seconds.

The other options indicate longer intervals: "c-2" is twice as slow as "c-1," "c-3" three times as slow, and so forth. The measurement interval setting is reflected on the data transmission rate.

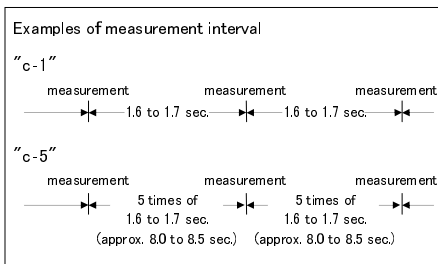

### ● Mode-S level: "d - #"

The Mode-S feature is designed to improve the measurement stability of samples that may have conventionally resulted in fluctuating readings.



There are 5 levels, wherein the larger the number is, the better the stability. For samples that give stable readings, the factory default level 1 is sufficient. Emulsions or opaque samples and/or temperature fluctuations may cause measurements to become unstable. Try adjusting the Mode-S level when this occurs.

## (2) Changing the Number of Decimal Places Displayed

① Turn on the power (24V DC) according to the instructions on page 22, "9. Power Supply."



The unit will display the real-time measurements in Brix(%).

② Hold down the  key for one second, and [0] will appear.

Each time the  key is pressed, the menu item displayed switches in the order of: [1], [2], [3], [4], and [5]. While [5] is displayed, press the  key.

"2" will appear. This means that readings will be displayed to the 2nd decimal place when Brix(%) values of less than 10% are measured.

Press the  key to change it to "1." This means that readings will be displayed to the 1st decimal place when Brix(%) values of less than 10% are measured.

③ Press the  and  key to switch back to "2." Press the  key, and [5] will appear.

④ Press the  key again to switch back to the real-time measurements in Brix(%).

**memo** The factory default is "2," which displays measurements of less than 10% Brix(%) to the 2nd decimal place.



## 12. Adjusting to the Reference



**Note** Before adjusting to a reference solution, confirm that the prism surface is clean.

**Note** Before adjusting to the reference with distilled water, set the temperature correction factor to "1.00".

- ① Confirm that the sample inlet unit is properly connected to the piping.
- ② Let distilled water or a reference sample flow through the piping.
- ③ Supply power to the CM-800 $\alpha$  referring to the procedure described in Chapter 9 "Power Supply" on page 22.

The current Brix(%) is displayed.

- ④ Press the  for one second. After [0] is displayed, press the  key once to display [1] (Fig.12-1). Then, press the  key.



- ⑤ When the Brix(%) value blinks, adjust the value to 0.0% for distilled water or to the true value for the reference sample by using the  and/or  keys (Fig.12-2).

- ⑥ Pressing the  sets the adjustment and the display returns to [1] (Fig.12-1).

- ⑦ Each time the  is pressed, the menu item displayed switches in the order of: [2], [3], [4], [5], and Brix(%). Select Brix(%) .

**memo** If 30 seconds pass when in steps ④ through ⑥ above, the display returns to the continuous Brix(%) display.

To reset the reference point to original factory settings

- ① While the Brix(%) is blinking in step ⑤ above, press and hold down both the  and  keys at the same time. After 5 seconds, the display will clear. Release the keys and the original standard Brix(%) will be displayed.

- ② The reference point is now reset to original factory settings.



Fig.12-1

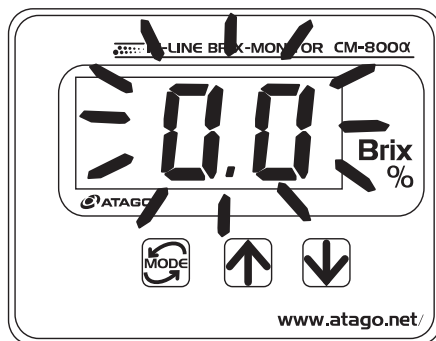

Fig.12-2 Example of the adjustment to the Brix 0.0%

## 13. Setting the Temperature Correction Values

### ● About temperature correction

The Refractive Index of every substance varies with the temperature. When measuring the Refractive Index of a liquid with a refractometer, the measurement value will also vary according to the sample temperature.

The CM-800  $\alpha$  detects the temperature of the prism, and the Brix(%) indication values are automatically corrected based upon the preset temperature correction values. When the sample temperature is within the range of 5 to 100°C, the Brix(%) values are automatically compensated for temperature.

### ● Setting the temperature correction values for the CM-800 $\alpha$

When the CM-800  $\alpha$  is shipped from the factory, the temperature correction values for sucrose have been set as the default. (☞ Table 13-1 page 27)

Fig.13-1 lists the temperature correction values for temperatures between 15 to 40°C.

However, temperature correction values for 5 to 100°C have been set on the CM-800  $\alpha$ .

If sugar is the main constituent of soluble solids in the sample, these values can be used as they are.

If the temperature correction factor is changed inadvertently, refer to page 28 "Inputting Temperature Correction Factor". By utilizing these instructions, it is possible to set the temperature correction factor back to "1.00".

### ● Setting procedure

If the main constituent of the sample is not sucrose, a different temperature correction value must be set.

To set a new temperature correction value, you must determine the relationship between the temperature correction factor for sucrose and your desired sample. The temperature correction factor for sucrose is 1.00. When a new temperature correction factor is input, this factor is multiplied by the temperature correction factor for sucrose.

The temperature correction factor can be set in the range of 0.80 to 5.00.







#### EXAMPLE :

If the Refractive Index variation of a sample due to temperature is 3 times larger than that of sucrose, the temperature correction factor should be set to 3.00.

Table 13-1 Table of temperature correction values for sucrose (g/100g) for refractometer (reference at 20°C, 589nm)

Temperature (°C)	Sucrose (g/100g)																	
	0	5	10	15	20	25	30	35	40	45	50	55	60	65	70	75	80	85
15	-0.29	-0.30	-0.32	-0.33	-0.34	-0.35	-0.36	-0.37	-0.37	-0.38	-0.38	-0.38	-0.38	-0.38	-0.38	-0.38	-0.37	-0.37
16	-0.24	-0.25	-0.26	-0.27	-0.28	-0.28	-0.29	-0.30	-0.30	-0.30	-0.31	-0.31	-0.31	-0.31	-0.31	-0.30	-0.30	-0.30
17	-0.18	-0.19	-0.20	-0.20	-0.21	-0.21	-0.22	-0.22	-0.23	-0.23	-0.23	-0.23	-0.23	-0.23	-0.23	-0.23	-0.23	-0.22
18	-0.12	-0.13	-0.13	-0.14	-0.14	-0.14	-0.15	-0.15	-0.15	-0.15	-0.15	-0.15	-0.15	-0.15	-0.15	-0.15	-0.15	-0.15
19	-0.06	-0.06	-0.07	-0.07	-0.07	-0.07	-0.07	-0.08	-0.08	-0.08	-0.08	-0.08	-0.08	-0.08	-0.08	-0.08	-0.08	-0.07
20	0.00	0.00	0.00	0.00	0.00	0.00	0.00	0.00	0.00	0.00	0.00	0.00	0.00	0.00	0.00	0.00	0.00	0.00
21	+0.06	+0.07	+0.07	+0.07	+0.07	+0.07	+0.08	+0.08	+0.08	+0.08	+0.08	+0.08	+0.08	+0.08	+0.08	+0.08	+0.08	+0.07
22	+0.13	+0.14	+0.14	+0.14	+0.15	+0.15	+0.15	+0.15	+0.16	+0.16	+0.16	+0.16	+0.16	+0.16	+0.15	+0.15	+0.15	+0.15
23	+0.20	+0.21	+0.21	+0.22	+0.22	+0.23	+0.23	+0.23	+0.23	+0.24	+0.24	+0.24	+0.24	+0.23	+0.23	+0.23	+0.23	+0.22
24	+0.27	+0.28	+0.29	+0.29	+0.30	+0.30	+0.31	+0.31	+0.31	+0.32	+0.32	+0.32	+0.32	+0.31	+0.31	+0.31	+0.30	+0.30
25	+0.34	+0.35	+0.36	+0.37	+0.38	+0.38	+0.39	+0.39	+0.40	+0.40	+0.40	+0.40	+0.40	+0.39	+0.39	+0.38	+0.38	+0.37
26	+0.42	+0.43	+0.44	+0.45	+0.46	+0.46	+0.47	+0.47	+0.48	+0.48	+0.48	+0.48	+0.48	+0.47	+0.47	+0.46	+0.46	+0.45
27	+0.50	+0.51	+0.52	+0.53	+0.54	+0.55	+0.55	+0.56	+0.56	+0.56	+0.56	+0.56	+0.56	+0.55	+0.55	+0.54	+0.53	+0.52
28	+0.58	+0.59	+0.60	+0.61	+0.62	+0.63	+0.64	+0.64	+0.64	+0.65	+0.65	+0.64	+0.64	+0.63	+0.63	+0.62	+0.61	+0.60
29	+0.66	+0.67	+0.68	+0.70	+0.71	+0.71	+0.72	+0.73	+0.73	+0.73	+0.73	+0.73	+0.72	+0.72	+0.71	+0.70	+0.69	+0.67
30	+0.74	+0.76	+0.77	+0.78	+0.79	+0.80	+0.81	+0.81	+0.82	+0.82	+0.81	+0.81	+0.80	+0.80	+0.79	+0.78	+0.76	+0.75
31	+0.83	+0.84	+0.85	+0.87	+0.88	+0.89	+0.89	+0.90	+0.90	+0.90	+0.90	+0.89	+0.89	+0.88	+0.87	+0.86	+0.84	+0.82
32	+0.92	+0.93	+0.94	+0.96	+0.97	+0.98	+0.98	+0.99	+0.99	+0.99	+0.99	+0.98	+0.97	+0.96	+0.95	+0.93	+0.92	+0.90
33	+1.01	+1.02	+1.03	+1.05	+1.06	+1.07	+1.07	+1.08	+1.08	+1.08	+1.07	+1.07	+1.06	+1.04	+1.03	+1.01	+1.00	+0.98
34	+1.10	+1.11	+1.13	+1.14	+1.15	+1.16	+1.16	+1.17	+1.17	+1.16	+1.16	+1.15	+1.14	+1.13	+1.11	+1.09	+1.07	+1.05
35	+1.19	+1.21	+1.22	+1.23	+1.24	+1.25	+1.25	+1.26	+1.26	+1.25	+1.25	+1.24	+1.23	+1.21	+1.19	+1.17	+1.15	+1.13
36	+1.29	+1.30	+1.31	+1.33	+1.34	+1.34	+1.35	+1.35	+1.35	+1.34	+1.34	+1.33	+1.31	+1.29	+1.28	+1.25	+1.23	+1.20
37	+1.39	+1.40	+1.41	+1.42	+1.43	+1.44	+1.44	+1.44	+1.44	+1.43	+1.43	+1.41	+1.40	+1.38	+1.36	+1.33	+1.31	+1.28
38	+1.49	+1.50	+1.51	+1.52	+1.53	+1.53	+1.54	+1.54	+1.53	+1.53	+1.52	+1.52	+1.48	+1.46	+1.44	+1.42	+1.39	+1.36
39	+1.59	+1.60	+1.61	+1.62	+1.63	+1.63	+1.63	+1.63	+1.63	+1.62	+1.61	+1.59	+1.57	+1.55	+1.52	+1.50	+1.47	+1.43
40	+1.69	+1.70	+1.71	+1.72	+1.73	+1.73	+1.73	+1.73	+1.72	+1.71	+1.70	+1.68	+1.66	+1.63	+1.61	+1.58	+1.54	+1.51

● Inputting the temperature correction factor

- ① Connect the power according to the procedure described on page 22, section "9. Power Supply".
- ② The current Brix(%) is displayed on the screen.  
If there is no sample on the prism surface, [L.L.L.] will be displayed.
- ③ Press the  key for one second.  
[0] is displayed.  
Press the  key again and the display will change to [2] (Fig.13-1).
- ④ Press the  key.  
The temperature correction factor will blink on the display (Fig.13-2).
- ⑤ If "1.00" is displayed, the temperature correction value is for sucrose.  
To change this setting, press the  or  keys until the desired factor is displayed.
- ⑥ Pressing the  key sets the adjustment of the temperature correction factor and the display returns to [2] (Fig.13-1).
- ⑦ Each time the  key is pressed, the menu item displayed switches in the order of: [3], [4], [5], and Brix(%).  
Select Brix(%)

 **memo** If 30 seconds or more has passed at any of the ③ through ⑥ stage, the display enters into the continuous display mode of the Brix(%) values.

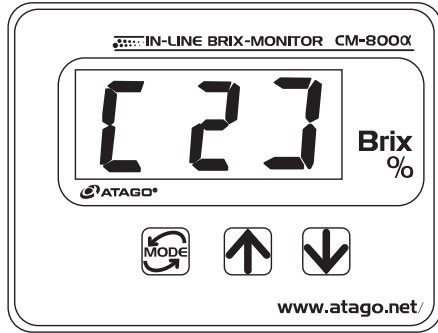

Fig.13-1

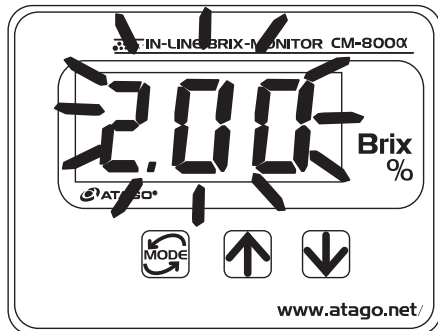

Fig.13-2 Example of the adjustment of the temperature correction factor to 2.00.

● Obtaining the temperature correction factor for a sample whose main constituent is other than sugar

- ① Measure distilled water and ensure that the Brix(%) value is 0.0%. If distilled water does not read 0.0%, see page 25, section "12.Adjusting to the Reference".
- ② Let the sample to be measured continuously run across the prism surface.  
Be sure to keep the sample temperature CONSTANT at less than 15°C, or greater than 25°C.
- ③ While letting the sample run, follow the directions on page 28 to display the temperature correction factor.  
Make sure this reads 1.00.
- ④ After the temperature correction factor is verified, return to the Brix(%) display.  
Note the Brix(%) value (A value).
- ⑤ Return to the temperature correction factor screen and adjust the temperature correction factor to 4.00.  
Return to the Brix(%) display and note the Brix(%) Value (B value).
- ⑥ The temperature correction factor for the sample can be obtained using the following formula:  
C value = true value — A value  
D value = true value — B value  
$$\text{Factor} = \frac{\text{D value} - (\text{C value} \times 4)}{\text{D value} - \text{C value}}$$
- ⑦ Set the obtained temperature correction factor according to the procedure described on page 28 (Any value in the range of 0.80 to 5.00 can be set as the factor).
- MEMO** To obtain the true value [Brix(%)] of the sample, measure the sample with a benchtop refractometer that can control the temperature (through a waterbath or Internal Peltier Thermo-module).  
The temperature should be 20°C.

Example of procedure

- ① Let distilled water run and adjust the Brix(%) value to 0.0%.
- ② Keep the sample less than 15°C or greater than 25°C.
- ③ Adjust the temperature correction factor to 1.00.
- ④ When returning to the Brix(%) value, 43.0% is displayed. This is the A value.
- ⑤ Adjust the temperature correction factor to 4.00.
- ⑥ Now, the Brix(%) value is 45.4%. This is the B value.
- ⑦ When measuring the sample with a benchtop refractometer at a constant temperature of 20°C, the true value is 45.0%.
- ⑧ To obtain the temperature correction factor from the above example:  
C value = true value — A value = 2.0  
D value = true value — B value = -0.4  
$$\text{Temperature correction factor} = \frac{-0.4 - (2.0 \times 4)}{-0.4 - 2.0} = 3.5$$
- ⑨ For this sample, the temperature correction factor should be set to 3.50.

## 14. Setting the Recorder Output

The CM-800  $\alpha$  can output a DC 4 to 20mA signal across a specified range of Brix(%). The upper and lower limit values can be set.









The lower limit value of Brix(%) should be set in the range of -2.0 to 79.5%.

The upper limit value of Brix(%) should be set in the range of -1.0 to 80.5%.

The difference between the upper and lower limit values should be greater than 1.0%.

For example, to output the Brix(%) value of 0.0 to 60.0% at DC 4 to 20mA, set the lower limit value to 0.0 and the upper limit value to 60.0.

### ● Setting procedure

- 1 Connect the power according to the procedure described on page 22, section "9. Power Supply".
- 2 The current Brix(%) is displayed on the screen. If there is no sample on the prism surface, [L.L.L.] will be displayed.
- 3 Press the  key for one second. [0] is displayed. Press the  key again and the display will change to [1]. Press the  key again to display [3] (Fig.14-1).
- 4 Press the  key. The current lower limit value will blink on the display (Fig.14-2).
- 5 Adjust the displayed value to the desired lower limit value by using the  and/or  keys (Fig.14-2).
- 6 Press the  key. The lower limit value is now set and the display returns to [3] (Fig.14-1).
- 7 Press the  key again and the display turns to [4] (Fig.14-3).

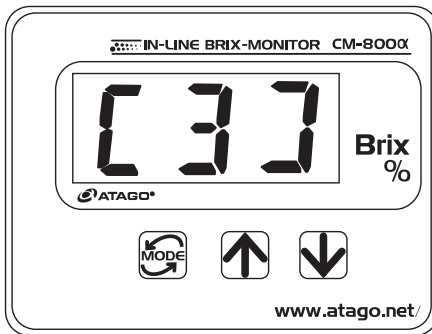

Fig.14-1

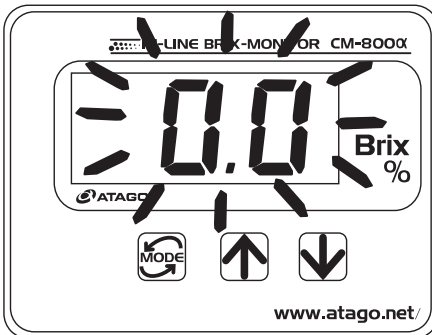

Fig.14-2 Example: When the lower limit value of the recorder output range is set to Brix 0.0%.

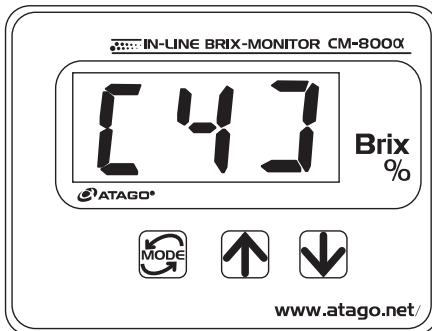





Fig.14-3



- ⑧ Press the  key.

The current upper limit value will blink on the display (Fig.14-4).

- ⑨ Adjust the displayed value to the desired upper limit value by using the  and/or  keys.

- ⑩ Press the  key.

The upper limit value is now set and the display returns to [4] (Fig.14-3).

- ⑪ Each time the  key is pressed, the menu item displayed switches in the order of: [5] and Brix(%).  
Select Brix(%).

**memo** If 30 seconds pass when in steps ③ through ⑩ above, the display returns to the continuous display of the Brix(%).

**Note** Recorder Output when an error message is displayed

Please take note of the recorder output signal when an error message is displayed on the CM-800  $\alpha$  unit.

Error Message	Recorder Output
LLL	4mA
HH.H	20mA
EE.E	20mA
...	Corresponds displayed Brix(%) value.

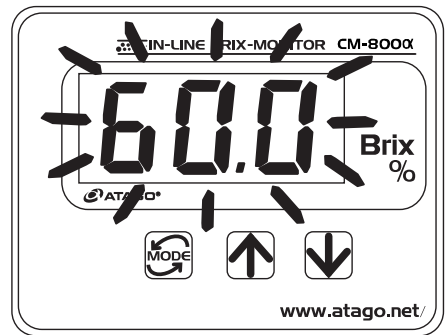

Fig.14-4 Example: When the upper limit value of the recorder output range is set to Brix 60.0%.

## 15. Cleaning the Prism



### WARNING

◇ Before running hazardous substance(s) through any system, necessary precautions should be taken to ensure the safe handling of the hazardous substance(s). If using a sample inlet unit, use caution when disconnecting the CM-800 $\alpha$  unit.



### CAUTION

◇ Cleaning liquids up to 150°C can be used for CIP or SIP. The cleaning liquid can be used safely for 30 minutes at one time. The momentary difference between the sample liquid temperature and the cleaning liquid temperature must be no more than 80°C.

When using cleaning liquids at temperatures over 150°C, the power source (DC24V) must be turned off. If the AD-32 (AD-33 or AD-34) is used, unplug from the outlet before cleaning.

① Detach the clamp band that connects the main unit to the sample inlet unit, piping or tank.

② Clean the prism surface carefully with a soft tissue soaked with warm water or ethyl alcohol. If the sample solution contains oil or grease, use ethyl alcohol to ensure the prism surface does not develop a film.

Development of a film on the prism could cause erroneous measurements.

③ NEVER clean the prism with an abrasive material.

Cleaning the prism with an abrasive material could cause scratches on the prism which could lead to erroneous measurements.

④ After cleaning is complete, re-attach the CM-800 $\alpha$  unit to the sample inlet unit, piping or tank.

The procedure is described on page 14 of this instruction manual.

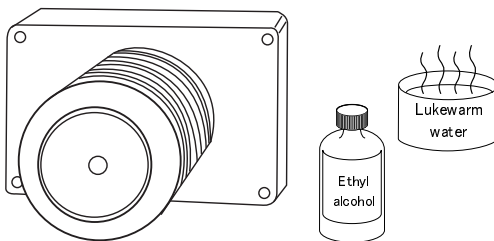

Fig.15-1

## 16. Error Codes & Troubleshooting

Error code	Possible causes	Actions to be taken
LL.L	The sample is not covering the prism surface completely.	Run a sample with a Brix(%) that is known to be within the indication range (Brix 0.0 to 80.0%). Confirm that the error code [LL.L] is replaced by the known Brix(%).
	A sample with a Brix(%) lower than the lower limit value of the indication range (Brix -2.0 to 80.5%) is being measured.	Run a sample with a Brix(%) that is known to be within the indication range (Brix 0.0 to 80.0%). If [LL.L] is still displayed, please refer to page 25, section "12. Adjusting to the Reference". Follow the instructions on this page to set the reference value to the Brix(%) of the known sample.
HH.H	A sample with a Brix(%) that exceeds the upper limit value of the indication range (Brix -2.0 to 80.5%) is being measured. If the Brix(%) of the sample is extremely high, the error code [EE.E] will be displayed.	Run a sample with a Brix(%) that is known to be within the indication range (Brix 0.0 to 80.0%). Confirm that the error code [HH.H] is replaced by the known Brix(%).
	The prism surface is dirty.	Run a sample with a Brix(%) that is known to be within the indication range (Brix 0.0 to 80.0%). If [HH.H] continues to be displayed, the prism surface may need to be cleaned. Clean the prism carefully as described on page 32.
EE.E	A sample with a Brix(%) that significantly exceeds the upper limit value of the indication range (Brix -2.0 to 80.5%) is being measured.	Run a sample with a Brix(%) that is known to be within the indication range (Brix 0.0 to 80.0%).
	The prism surface is dirty.	If [EE.E] is displayed and the sample is known to have a Brix(%) within the indication range, the prism surface may need to be cleaned. Clean the prism carefully as described on page 32. If [EE.E] is continually displayed after the above procedures have been carried out, please contact an Authorized ATAGO Distributor.
...	The prism temperature is below 0°C or above 130°C. In this case, the displayed Brix(%) value is not properly corrected for temperature.	Run a sample at a temperature of 5 to 100°C. When doing so, confirm that [...] disappears.

\* Please see Page 31 "Recorder Output when an error message is displayed."

## 17. Consumable Parts and Optional Items

### (1) Consumable Parts

The following consumable parts are available for the CM-800 $\alpha$  In-line Brix Monitor.

These items should be monitored and replaced as necessary. To place an order, please contact an Authorized

ATAGO Distributor.

Part name	Part number	Description
Tie band	RE-8507	Maximum temperature: Max. 150°C Quantity: 10 pieces For water bath connection
O-ring	RE-68002	O-ring used to connect the sample inlet unit to the prism stage unit of the CM-800 $\alpha$ .

### (2) Optional Items

The following optional items are available for the CM-800 $\alpha$  In-line Brix Monitor.

These items can be ordered through an Authorized ATAGO Distributor.

(☞ “3.Unpacking and Installation” page 9)

Product or part name		Catalog or part number	Description
AC adapter AD-32		Cat.No.3527	Converts the AC 100V to the DC24V and supplies the power to the CM-800 $\alpha$ .
AC adapter AD-33		Cat.No.3528	Converts the AC 110V to the DC24V and supplies the power to the CM-800 $\alpha$ .
AC adapter AD-34		Cat.No.3529	Converts the AC 220-240V to the DC24V and supplies the power to the CM-800 $\alpha$ .
Sample inlet unit	Hose connector	RE-67501	Outside diameter of the Hose connector: 12mm $\phi$
	Compression Fitting	RE-67503	Compression fitting 10mm $\phi$
	Straight type IDF/ISO clamp union (ferrule)	RE-67511	1S
		RE-67512	1.5S
		RE-67521	2S
	Straight type IDF/ISO screw union (screw)	RE-67523	2S
	Straight type JIS Flange	RE-67515	25A
RE-67525		40A	
L type IDF/ISO clamp union (ferrule)	RE-67611	1S	
	RE-67621	2S	
Recorder output cable		RE-5635	4-pin connector, one-sided crimp contact (5m)
		RE-5636	4-pin connector, one-sided crimp contact (10m)
		RE-5638	4-pin connector, one-sided crimp contact (15m)
		RE-5639	4-pin connector, one-sided crimp contact (20m)
RS-232C cable D-SUB 25-pin		RE-5647	4-pin connector, one-sided D-SUB 25-pin connector * Please specify the length (1 to 15m) upon ordering.
		RE-5677	4-pin connector, one-sided D-SUB 25-pin connector (15m)
RS-232C cable D-SUB 9-pin		RE-65331	4-pin connector, one-sided D-SUB 9-pin connector * Please specify the length (1 to 15m) upon ordering.
		RE-65330	4-pin connector, one-sided D-SUB 9-pin connector (15m)
Stand		RE-8607	Stand for mounting the CM-800 $\alpha$ and the AD-32 (AD-33 or AD-34).

## 18. Relationships between Brix(%) Values and Refractive Index (nD) Values

The relationships between Brix(%) values and Refractive Index (nD) values are listed in this table for your reference.

%	n <sub>D</sub> <sup>20</sup>	%	n <sub>D</sub> <sup>20</sup>	%	n <sub>D</sub> <sup>20</sup>	%	n <sub>D</sub> <sup>20</sup>	%	n <sub>D</sub> <sup>20</sup>
0	1.33299	20	1.36384	40	1.39986	60	1.44193	80	1.49071
1	1.33442	21	1.36551	41	1.40181	61	1.44420	81	1.49333
2	1.33586	22	1.36720	42	1.40378	62	1.44650	82	1.49597
3	1.33732	23	1.36889	43	1.40576	63	1.44881	83	1.49862
4	1.33879	24	1.37060	44	1.40776	64	1.45113	84	1.50129
5	1.34026	25	1.37233	45	1.40978	65	1.45348	85	1.50398
6	1.34175	26	1.37406	46	1.41181	66	1.45584		
7	1.34325	27	1.37582	47	1.41385	67	1.45822		
8	1.34477	28	1.37758	48	1.41592	68	1.46061		
9	1.34629	29	1.37936	49	1.41799	69	1.46303		
10	1.34782	30	1.38115	50	1.42009	70	1.46546		
11	1.34937	31	1.38296	51	1.42220	71	1.46790		
12	1.35093	32	1.38478	52	1.42432	72	1.47037		
13	1.35250	33	1.38661	53	1.42647	73	1.47285		
14	1.35408	34	1.38846	54	1.42863	74	1.47535		
15	1.35568	35	1.39032	55	1.43080	75	1.47787		
16	1.35729	36	1.39220	56	1.43299	76	1.48040		
17	1.35891	37	1.39409	57	1.43520	77	1.48295		
18	1.36054	38	1.39600	58	1.43743	78	1.48552		
19	1.36218	39	1.39792	59	1.43967	79	1.48811		

Refractive Index values correlating to Brix 0 to 85% in the table above have been officially determined by ICUMSA (International Committee of Uniform Method of Sugar Analysis held in 1974).

## 19. Specifications

Cat.No.	3564
Measurement scale	Brix(%) (Automatic Temperature Compensation), Temperature
Measurement range	Brix 0.00 to 80.0% (indication: -2.0 to 80.5%), Temperature 5 to 100°C (indication: 0 to 130°C)
Resolution	Brix 0.01 or 0.1% (by selection; 0.00 to 9.99%) Brix 0.1% (10.0 to 80.0%)
Measurement accuracy	Brix $\pm 0.1\%$ (based on sucrose solution)
Measurement temperature	5.0 to 100.0°C (Automatic Temperature Compensation range)
Temperature correction values	Based on the temperature correction table for sucrose. For 15 to 40°C, ICUMSA (International Committee of Unified Method of Sugar Analysis) values are used. For 5 to 15°C or 40 to 100°C, the values obtained at the ATAGO laboratories are used. The temperature correction values for sucrose can be multiplied by any factor in the range of 0.80 to 5.00.
Output (Optional Cables)	① Recorder output: DC 4 to 20mA Any value between Brix 1% through 80% can be set. ② RS-232C output
Source	LED (D-line approximation)
Temperature sensor	Thin film platinum sensor
Materials in contact with the solution	Prism : Artificial sapphire Prism stage : SUS316
Wetted parts materials	-30 to 150°C
Resistible pressure on the prism unit	0.98MPa(10kgf/cm <sup>2</sup> )
International Protection Class	IP64
Power supply	100 to 240V (50/60Hz) (voltage fluctuation not to exceed $\pm 10\%$ ) CM-800 $\alpha$ : DC24V (Allowable fluctuation is $\pm 10\%$ ) AC adapter AD-32, AD-33 or AD-34 (optional); AC 100-240V 50/60Hz
Power consumption	3VA
Environmental conditions	<ul style="list-style-type: none"> <li>• Use the instrument at an altitude below 2,000m (above sea level).</li> <li>• Use the instrument indoors.</li> <li>• Use the instrument where the temperature is between 5 to 40°C.</li> <li>• Use the instrument under the condition where humidity is 80% at 31°C or lower, falling linearly to 50% at 40°C.</li> <li>• Main supply voltage fluctuation should not to exceed <math>\pm 10\%</math> the nominal voltage.</li> <li>• Installation categories (Overvoltage Categories) : II</li> <li>• The pollution degree is 2 (according to IEC60664).</li> </ul>

## 20. Dimensions

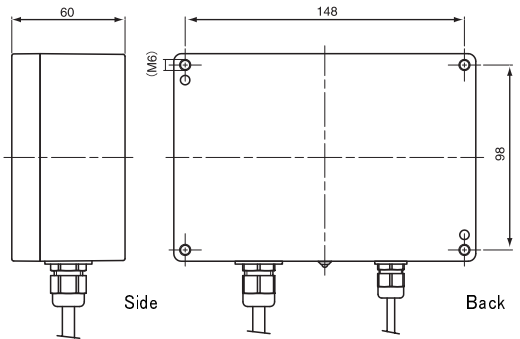
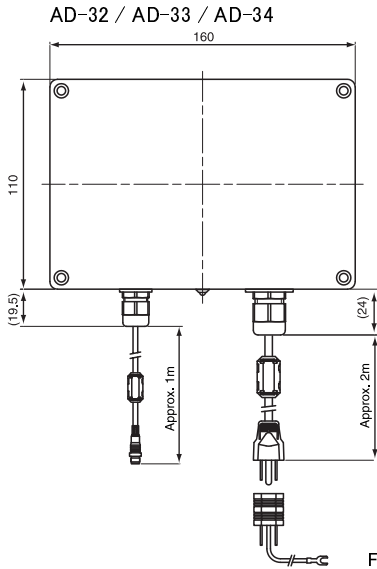
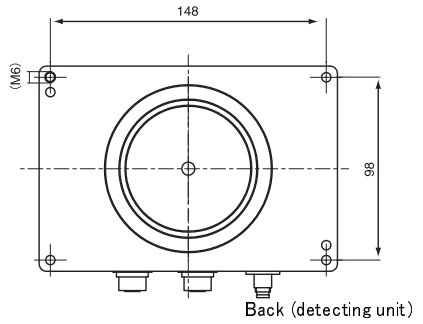
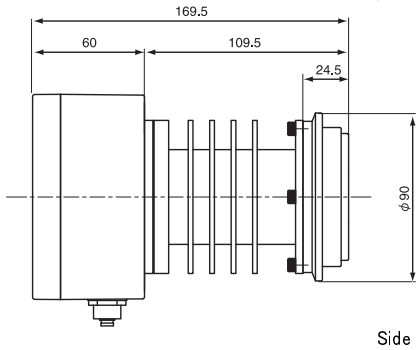
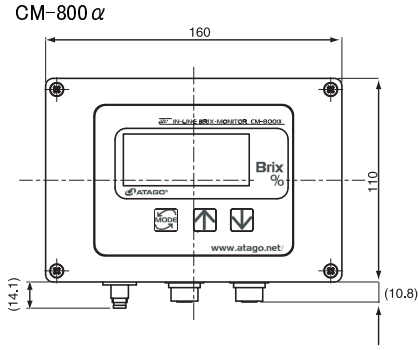

# 21. Repair Service and Warranty Period

The CM-800 $\alpha$  In-line Brix-Monitor is a precise electronic instrument which incorporates both optical and electrical components. Due to the complex interaction of these components, repairs and/or adjustments of the CM-800 $\alpha$  unit must be performed by an ATAGO engineer or a properly trained service technician at an ATAGO Authorized Service Center. Authorized Service Center technicians have completed maintenance courses and have a vast knowledge of ATAGO instruments. Any simple inspection or replacement of parts described in this manual can be performed by the end-user. Only ATAGO engineers and properly trained service technicians are allowed to perform repairs or disassemble the CM-800 $\alpha$ . Any attempt to make repairs or disassemble the unit will void the warranty.

The warranty period of the CM-800 $\alpha$  is one year from the date of purchase. This warranty covers manufacturer's defects. If any manufacturer's defect is found during the warranty period, the CM-800 $\alpha$  will be repaired under warranty. The prism of the CM-800 $\alpha$  is considered a consumable item and is not covered under the warranty.

All instruments received for repair are subject to a possible inspection fee. If the unit is inspected and found to be either in good working order or is not covered by the warranty, the customer will be responsible for any inspection fees, repair costs including labor, parts and materials use, and shipping charges.

## ● Replacement Part Information

Please note that ATAGO cannot guarantee that replacement parts will be available after a unit has been discontinued. ATAGO will make every effort to secure replacement parts for a period of at least seven years after discontinuation of any product.

## ● Periodic inspection service (charged)

To ensure long-term, precise and stable operation of the CM-800 $\alpha$ , we recommend for the unit to be inspected periodically (at least once every two years).

Periodic inspection service can be requested through an Authorized ATAGO Distributor or directly from an Authorized Service Center.

Periodic inspection service includes.

- Inspection, confirmation and replacement of functional parts (if necessary)
- Inspection and adjustment of the span
- Cleaning the prism
- Replacement of the dehumidifying agent

ATAGO CO., LTD.

When contacting your preferred distributor regarding repairs or troubleshooting, please inform them of the serial number of the unit.



# twilight

INSTRUMENTOS DE MEDICIÓN INDUSTRIAL



LLÁMANOS

+52(81) 8115-1400 / +52 (81) 8173-4300

LADA Sin Costo:  
01 800 087 43 75

E-mail:  
[ventas@twilight.mx](mailto:ventas@twilight.mx)

[www.twilight.mx](http://www.twilight.mx)